

FS-G4P-BS

USER MANUAL

FLYSKY

Digital Proportional Radio Control System

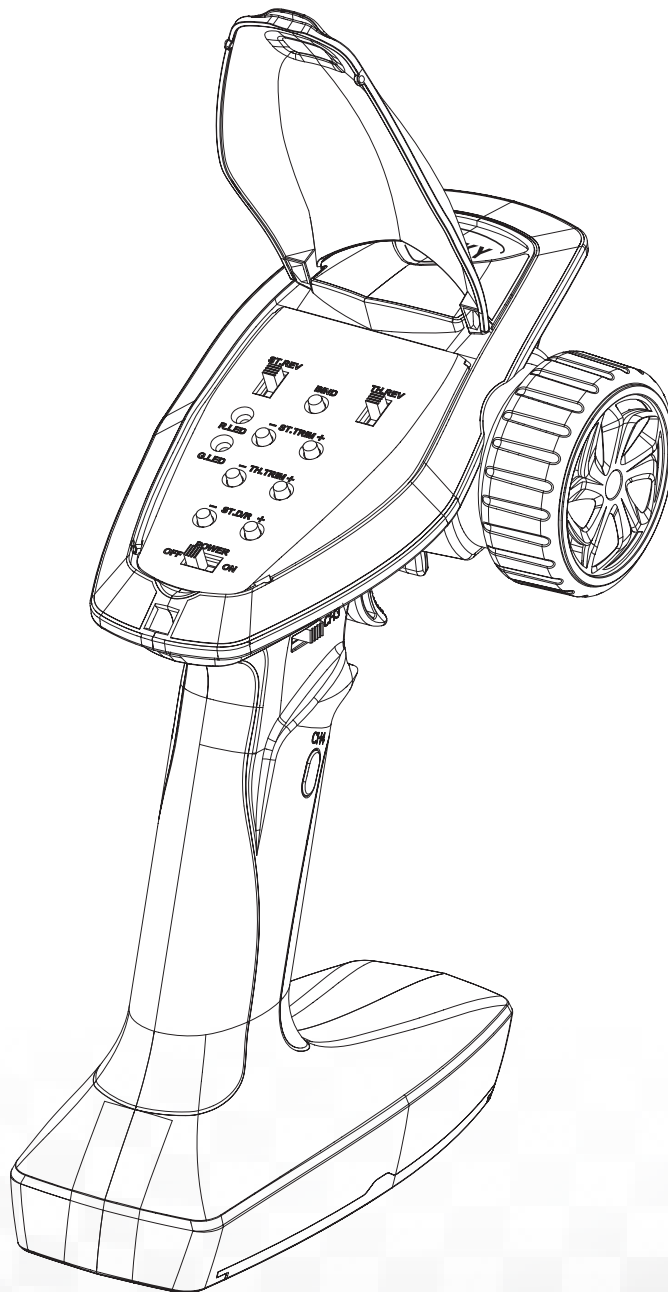

Copyright ©2021 Flysky Technology co., ltd

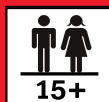

WARNING:
This product is only for 15 years
old or above.



Thank you for purchasing our products.

Read the manual carefully to ensure your personal safety as well as the safety of your equipment.

If you encounter any problems during using, please refer to this manual first. If the problem is still not resolved, please contact the local dealer directly or contact the customer service staff via the website below:

www.flysky-cn.com



Contents

1.Safety	1
1.1 Safety Symbols	1
1.2 Safety Guide.....	1
Mandatory	1
2.Introduction.	2
2.1 Transmitter overview.....	2
2.2 Receiver overview	4
3.Getting Started	5
3.1 Transmitter Battery Installation	5
4.Instructions	6
4.1 Power On	6
4.2 Binding	6
4.3 Stick Calibration	7
4.4 Power Off	7
5.System Functions.	8
5.1 Channel Description	8
5.2 Channel Reverse	8
5.3 Trims	8
5.4 D/R.....	9
5.5 Mode switching.....	9
5.6 Failsafe	9
5.7 Beginner Mode.....	10
6. Product Specifications	11
7. Package Contents	12
8. Certifications	13
8.1 DoC Declaration.....	13
8.2 CE Warning.....	13
8.3 Appendix 1 FCC Statement	13
8.4 Environmentally friendly disposal	14
8.5 IC STATEMENT	14

1. Safety

1.1 Safety Symbols

Pay close attention to the following symbols and their meanings. Failure to follow these warnings could cause damage, injury or death.

 Danger	• Not following these instructions may lead to serious injuries or death.
 Warning	• Not following these instructions may lead to major injuries.
 Attention	• Not following these instructions may lead to minor injuries.

1.2 Safety Guide



Prohibited



Mandatory



- **Do not use the product at night or in bad weather like rain or thunderstorm. It can cause erratic operation or loss of control.**
- **Do not use the product when visibility is limited.**
- **Do not use the product on rain or snow days. Any exposure to moisture (water or snow) may cause erratic operation or loss of control.**
- **Interference may cause loss of control. To ensure the safety of you and others, do not operate in the following places:**
 - Near any site where other radio control activity may occur
 - Near power lines or communication broadcasting antennas
 - Near people or roads
 - On any body of water when passenger boats are present
- **Do not use this product when you are tired, uncomfortable, or under the influence of alcohol or drugs. Doing so may cause serious injury to yourself or others.**
- **The 2.4GHz radio band is limited to line of sight. Always keep your model in sight as a large object can block the RF signal and lead to loss of control.**
- **Do not touch any part of the model that may generate heat during operation, or immediately after use. The engine, motor or speed control, may be very hot and can cause serious burns.**



- **Misuse of this product may lead to serious injury or death. To ensure the safety of you and your equipment, read this manual and follow the instructions.**
- **Make sure the product is properly installed in your model. Failure to do so may result in serious injury.**
- **Make sure to disconnect the receiver battery before turning off the transmitter. Failure to do so may lead to unintended operation and cause an accident.**
- **Ensure that all motors operate in the correct direction. If not, adjust the direction first.**
- **Make sure the model stays within the systems maximum range to prevent loss of control.**

2. Introduction

The FS-G4P-BS is a simple 4-channel transmitter using the latest 2.4GHz 2A-BS Automatic Frequency Hopping Digital System. Designed to be sleek, passionate and powerful for entry level enthusiasts.

2.1 Transmitter overview

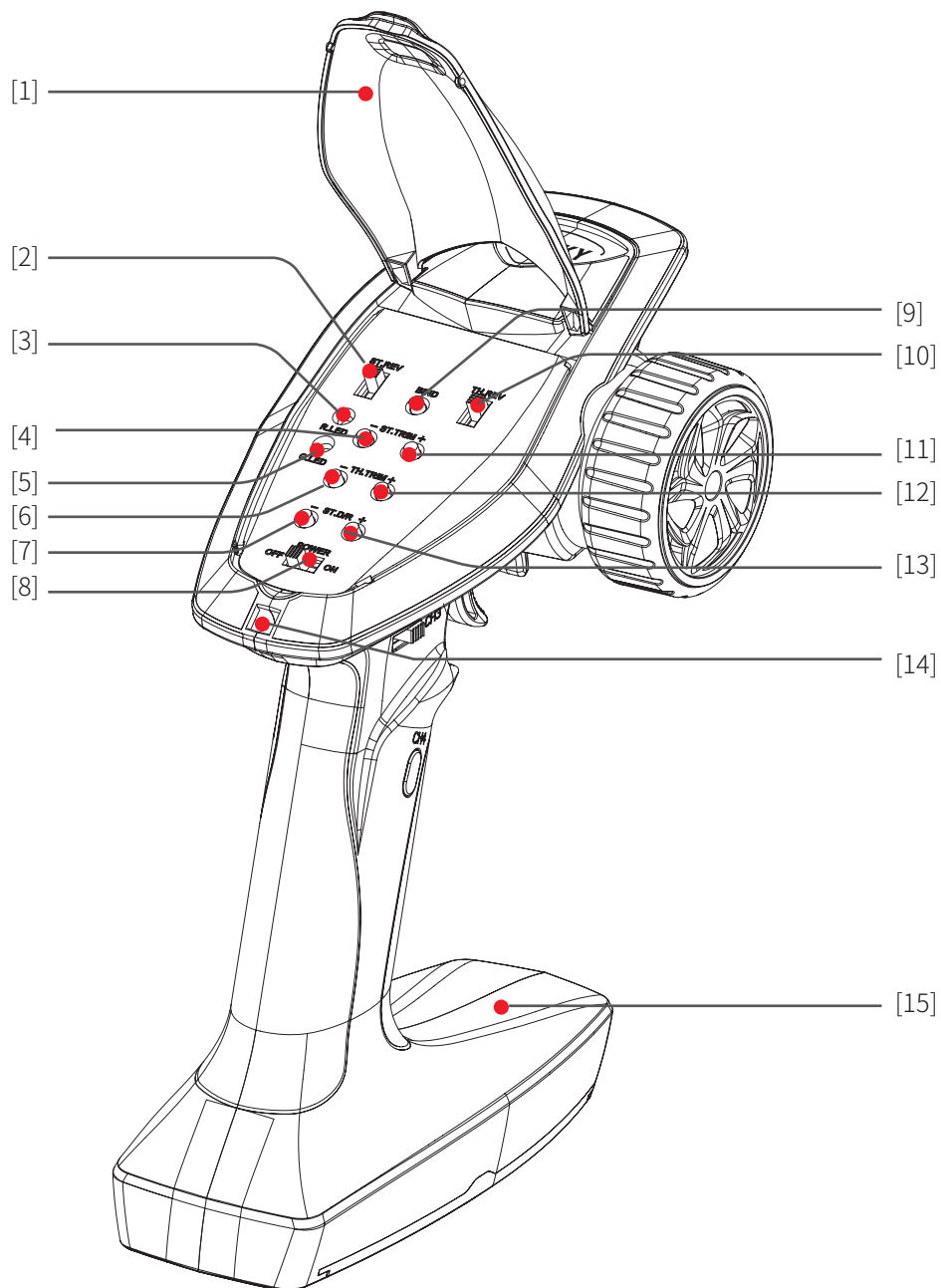

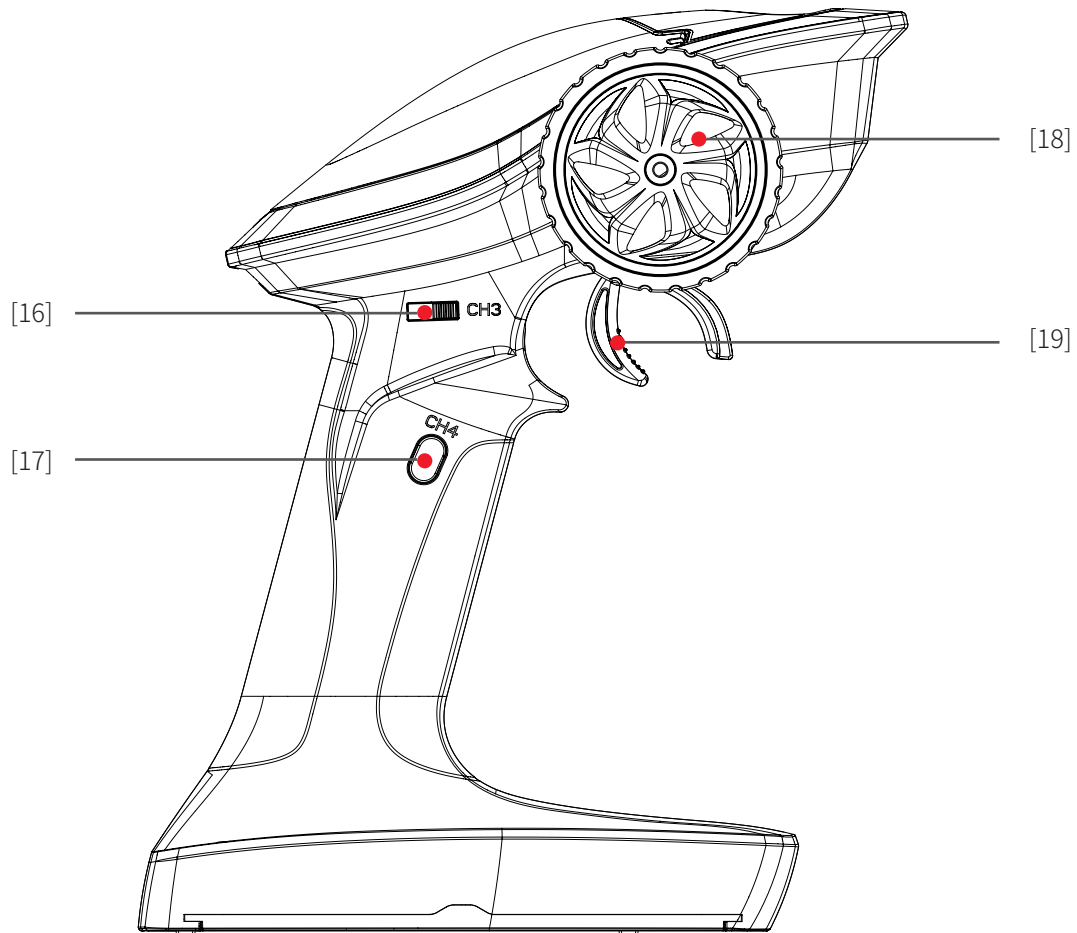

[1]	Panel Flip Cover	[11]	Steering Trim (ST.TRIM +)
[2]	Steering Reverse Switch (ST.REV)	[12]	Throttle Trim (TH.TRIM +)
[3]	Power indicator LED (R. LED)	[13]	Steering D/R (ST.D / R +)
[4]	Steering Trim (ST.TRIM-)	[14]	Lanyard Eye
[5]	Status indicator green LED (G.LED)	[15]	Base, 4 * AA battery compartment
[6]	Throttle Trim (TH.TRIM-)	[16]	Three-position switch (CH3)
[7]	Steering D/R (ST.D / R-)	[17]	Button (CH4)
[8]	Power Switch	[18]	Wheel Angle, the maximum rotation of the steering wheel is 35 degrees from center to left or right (CH1)
[9]	Bind Button (BIND)	[19]	Throttle trigger, has a total throw of 12 degrees, 12.5 degrees forward, and 12.5 degrees backward (CH2)
[10]	Throttle Reverse (TH.REV)		

2.2 Receiver overview

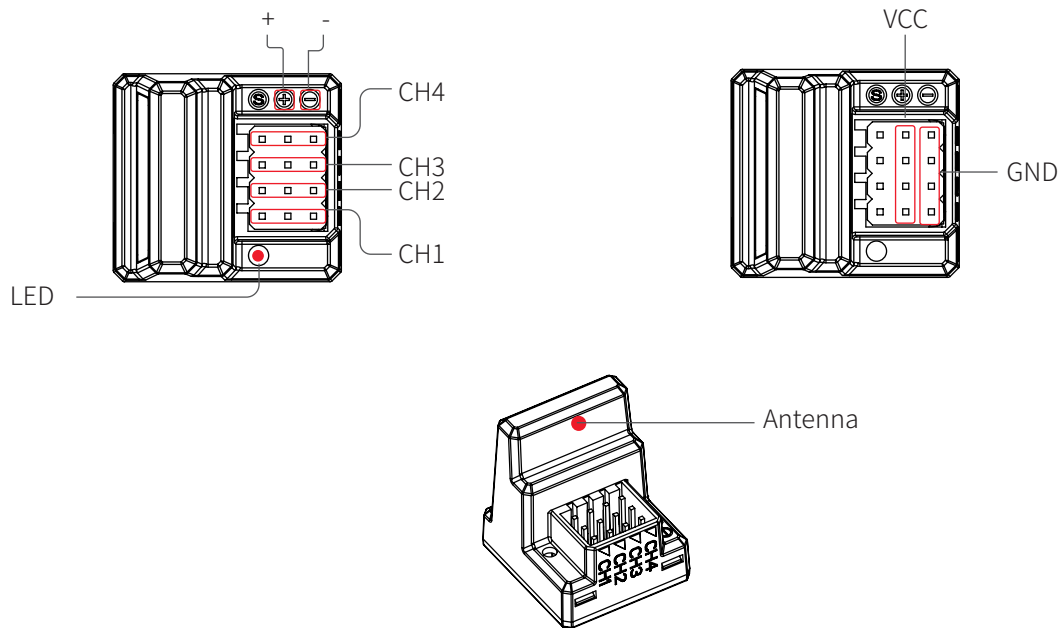







Note

- To ensure the best signal quality make sure that the antenna is mounted perpendicular to the model body in an upright position.

3. Getting Started

Before operation, install the battery and connect the system as instructed below.

3.1 Transmitter Battery Installation

 Danger	• Only use specified battery (X4 AA batteries).
 Danger	• Do not open, disassemble, or attempt to repair the battery.
 Danger	• Do not crush/puncture the battery, or short the external contacts.
 Danger	• Do not expose to excessive heat or liquids.
 Danger	• Do not drop the battery or expose to strong shocks or vibrations.
 Danger	• Always store the battery in a cool, dry place.
 Danger	• Do not use the battery if damaged.

Battery Type: AA

Battery Installation:

1. Open the battery compartment cover.
2. Insert 4 fully-charged AA batteries into the compartment. Make sure that the battery makes good contact with the battery compartment's contacts.
3. Replace battery compartment cover.

Low battery alarm: When the battery is lower than 4.2v, the G.LED on the panel will flash slowly.

4. Instructions

After setting up, follow the instructions below to operate the system.

4.1 Power On

Follow the steps below to turn on the transmitter:

1. Check to make sure that that battery is fully charged and installed correctly.
2. Toggle the switch to the [ON] position. When active the R.LED will be lit.
3. Power on the receiver.
 - For safety always power on the transmitter before the receiver.



Note

- **Operate with caution in order to avoid damage or injury.**



Note

- **Make sure that the throttle is at its lowest position and the switches are set to their up position.**

4.2 Binding

The transmitter and receiver have already been bound at the factory.

However if the receiver needs to be replaced or additional receivers bound follow these steps:

1. Turn on the transmitter while holding the bind button to enter bind mode. G.LED will start flashing quickly.
 - Once in bind mode release the bind button.
2. The receiver will enter bind mode atomically when powered on.
3. Once binding is successful the receiver's LED will flash slowly and the transmitter's LED will remain solid after being rebooted.

Note: When binding, put the transmitter into bind mode first, then the receiver.

- **Applicable to the FS-G4P-BS transmitter and the FS-R4P-BS receiver. Different receivers have different bind procedures. For more information visit the FLYSKY website for manuals and other related information.**

- **Product information is updated regularly, please visit our website for more information.**

4.3 Stick Calibration

This function is used to set the neutral position for throttle trigger and steering wheel.

Every transmitter is calibrated before leaving the factory, however if recalibration is required, please follow these steps:

1. Turn and hold the wheel as far clockwise as it will turn, hold the throttle all the way forward, then turn on the transmitter in calibration mode.
 - The R.LED and G.LED will be in a state of two-time flashing and on off.
2. Calibrate wheel: Turn the wheel completely clockwise, then completely counterclockwise.
 - When calibration is completed the R.LED will be off.
3. Trigger calibration: Pull the trigger back then forward as far as it will go.
 - When calibration is completed the G.LED will be off.
4. Once calibration is complete press the bind to save and exit.

4.4 Power Off

Follow the steps below to turn off the system:

1. Disconnect the receiver power.
2. Toggle the transmitter's power switch to the [OFF] position.

 Danger	<ul style="list-style-type: none">• Make sure to disconnect the receiver power before turning off the transmitter. Failure to do so may lead to damage or serious injury.
--	--

5. System Functions

This section focuses on the functions and how to use them.

5.1 Channel Description

The transmitter outputs a total of 4 channels, which are allocated as follows:

- CH1: Steering Wheel
- CH2: Throttle Trigger
- CH3: Three-position Switch
- CH4: Reset Button

Note: By default the output of CH4 is 1000us, after which pressing the button will toggle between 1000 and 2000us.

5.2 Channel Reverse

This function is used to adjust each channels direction of movement in relation to its input. The ST.REV / TH.REV switches are the reverse buttons for CH1 and CH2. If the switch is up it indicates reverse, and the down indicates normal.

5.3 Trims

The ST.TRIM is the trims for CH1 (steering),and can be multiplexed as trims of CH3 and CH4. For multiplexing switching mode, refer to [5.5 Mode Switching].

TH.TRIM is the trims for CH2(throttle).

Adjustment range: -120us- + 120us, each step is 4us;

ST.TRIM + / TH.TRIM +: Increases adjustment step;

ST.TRIM- / TH.TRIM-: Decreases adjustment step.

LED Indicator:

- When using the trim keys the G.LED will flash slowly on short presses and quickly on long presses.
- When the trim adjustment value is at the neutral position, the G.LED will flash twice slowly.
- When the trim adjustment value is at both ends (+ 120us / -120us), the trim adjustment is at its maximum and as such G.LED will not flash (If the fine adjustment value has been adjusted to + 120us, then press ST.TRIM + / TH.TRIM + key is invalid and G.LED has no indications.)

5.4 D/R

ST.D / R is for servo travel adjustment, which can be multiplexed as CH2 (throttle), CH3, CH4 servo travel adjustment, refer to [5.5 Mode Switch] for multiplex switching mode;

Adjustment range: 0-120%(the default is 100%), the step is 5%.

ST.D / R +: Increases servo travel.

ST.D / R -: Decreases servo travel.

LED Indicator:

- When using the trim keys the G.LED will flash slowly on short presses and quickly on long presses.
- When the ratio value is at both ends (0/120%), the ST.D / R button is at its maximum and as such G.LED will not flash(if the ratio value has been adjusted to 120%, then press ST.D/R+ key is invalid and G.LED has Instructions)

5.5 Mode switching

This function is for reusing the ST.TRIM and ST.D / R buttons for different channels (Refer to [5.3 Trims] and [5.4 D/R]).

Function settings:

Under normal power-on, quickly press the Bind button twice (within 1 second) to cycle through modes 1, 2, 3, and 4. The default setting when powering on is mode 1.

Mode 1: G.LED flashes slowly once, ST.TRIM is CH1 trim adjustment, ST.D / R is servo travel adjustment.

Mode 2: G.LED flashes twice slowly, ST.TRIM is CH1 trim adjustment, ST.D / R is CH2 servo travel adjustment.

Mode 3: G.LED flashes three times slowly, ST.TRIM is CH3 trim adjustment, ST.D / R is CH3 servo travel adjustment.

Mode 4: G.LED flashes slowly four times, ST.TRIM is CH4 trim adjustment, ST.D / R is CH4 servo travel adjustment.

5.6 Failsafe

This function dictates what the receiver will do in the event that it loses signal from the transmitter, this includes servo position etc.

Function settings:

1. Turn on the transmitter and make sure it is connected to the receiver.
2. Hold the control surface at the desired failsafe position.
3. Press and hold the bind button for 3 seconds, if the G.LED starts flashes for 2 seconds, indicating that the settings are successful.

Note: The fail-safe function has not set at the factory by default. If no failsafe setting has been set, then the receiver will maintain the output of the last signal when the signal is lost.

5.7 Beginner Mode

Beginner mode is designed for the people who is new to the hobby.

In this mode the throttle has been limited to 50 percent, The channel range defaults has been set to 1250~1500~1750us.

Function settings:

To switch between beginner and normal modes, press and hold the CH4 button while turning the steering wheel completely counterclockwise as far as it can, and at the same time, power on the transmitter.

Note: By default, the system is set to normal mode. If the system has set to beginner mode.

The G.LED will be in a state of two-time flashing and on off, and keep the state for 3 seconds during power on.

6. Product Specifications

This section contains the specifications of FS-G4P-BS transmitter.

Product Model	FS-G4P-BS
Channels	4
Model Type	Cars, Boats
RF	2.4GHz
Maximum Power	<20dBm (e.i.r.p.) (EU)
2.4GHz Protocol	2A-BS
Distance	>300m (Ground)
Channel Resolution	1024
Battery	6V DC 1.5AA*4
Charging Interface	NO
Life time	According to battery type
Low Voltage Warning	<4.2V
Antenna Type	Built-in single antenna
Data Interface	NO
Temperature Range	-10°C—+60°C
Humidity Range	20%—95%
Online Update	NO
Color	Black
Size	160*193*97mm
Weight	220g
Certification	CE, FCC ID: N4ZG4P00

7. Package Contents

Transmitter*1(FS-G4P-BS)

Receiver*1(FS-R4P-BS)

8. Certifications

8.1 DoC Declaration

Hereby, [Flysky Technology co., Ltd] declares that the Radio Equipment [FS-G4P-BS] is in compliance with RED 2014/53/EU.

The full text of the EU DoC is available at the following internet address: www.flysky-cn.com.

8.2 CE Warning

The antenna(s) used for this transmitter must be installed to provide a separation distance of at least 20 cm from all persons and must not be co-located or operating in conjunction with any other transmitter. End-users and installers must be provided with antenna installation instructions and transmitter operating conditions for satisfying RF exposure compliance.

8.3 Appendix 1 FCC Statement

This equipment has been tested and found to comply with the limits for a Class B digital device pursuant to part 15 of the FCC rules. These limits are designed to provide reasonable protection against harmful interference in a residential installation. This equipment generates, uses and can radiate radio frequency energy and, if not installed and used in accordance with the instructions, may cause harmful interference to radio communications. However, there is no guarantee that interference will not occur in a particular installation. If this equipment does cause harmful interference to radio or television reception, which can be determined by turning the equipment off and on, the user is encouraged to try to correct the interference by one or more of the following measures:

- Reorient or relocate the receiving antenna.
- Increase the separation between the equipment and receiver.
- Connect the equipment into an outlet on a circuit different from that to which the receiver is connected.
- Consult the dealer or an experienced radio/TV technician for help.

To assure continued compliance, any changes or modifications not expressly approved by the party responsible for compliance could void the user's authority to operate this equipment.

This equipment complies with Part 15 of the FCC Rules. Operation is subject to the following two conditions:

(1) This device may not cause harmful interference, and (2) This device must accept any interference received, including interference that may cause undesired operation.

Caution!

The manufacturer is not responsible for any radio or TV interference caused by unauthorized modifications to this equipment. Such modifications could void the user authority to operate the equipment.

1. The antenna(s) used for this transmitter must be installed to provide a separation distance of at least 20 cm from all persons and must not be co-located or operating in conjunction with any other transmitter. End-users and installers must be provided with antenna installation instructions and transmitter operating conditions for satisfying RF exposure compliance.
2. Move all your channels to the desired position.
3. Select [All channels] and then [Yes] in the confirmation box.

8.4 Environmentally friendly disposal

Old electrical appliances must not be disposed of together with the residual waste, but have to be disposed of separately. The disposal at the communal collecting point via private persons is for free. The owner of old appliances is responsible to bring the appliances to these collecting points or to similar collection points. With this little personal effort, you contribute to recycle valuable raw materials and the treatment of toxic substances.

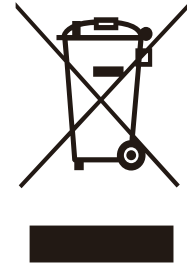

CAUTION

RISK OF EXPLOSION IF BATTERY IS REPLACED BY AN INCORRECT TYPE.
DISPOSE OF USED BATTERIES ACCORDING TO THE INSTRUCTIONS

8.5 IC STATEMENT

This device contains licence-exempt transmitter(s)/receiver(s) that comply with Innovation, Science and Economic Development Canada's licence-exempt RSS(s). Operation is subject to the following two conditions:

- (1) This device may not cause interference.
- (2) This device must accept any interference, including interference that may cause undesired operation of the device.

L' émetteur/récepteur exempt de licence contenu dans le présent appareil est conforme aux CNR d' Innovation, Sciences et Développement économique Canada applicables aux appareils radio exempts de licence. L' exploitation est autorisée aux deux conditions suivantes :

1. L' appareil ne doit pas produire de brouillage;
2. L' appareil doit accepter tout brouillage radioélectrique subi, même si le brouillage est susceptible d' en compromettre le fonctionnement.

IC: 25584-G4PBS00

FLYSKY

www.flysky-cn.com

Copyright ©2021 Flysky Technology co., ltd

Release date: 2021-10-23



CE, FCC ID: N4ZG4P00

Manufacturer: FLYSKY Technology Co., Ltd
Address: 16F, Huafeng Building, 6006 Shennan Road, Futian District, Shenzhen