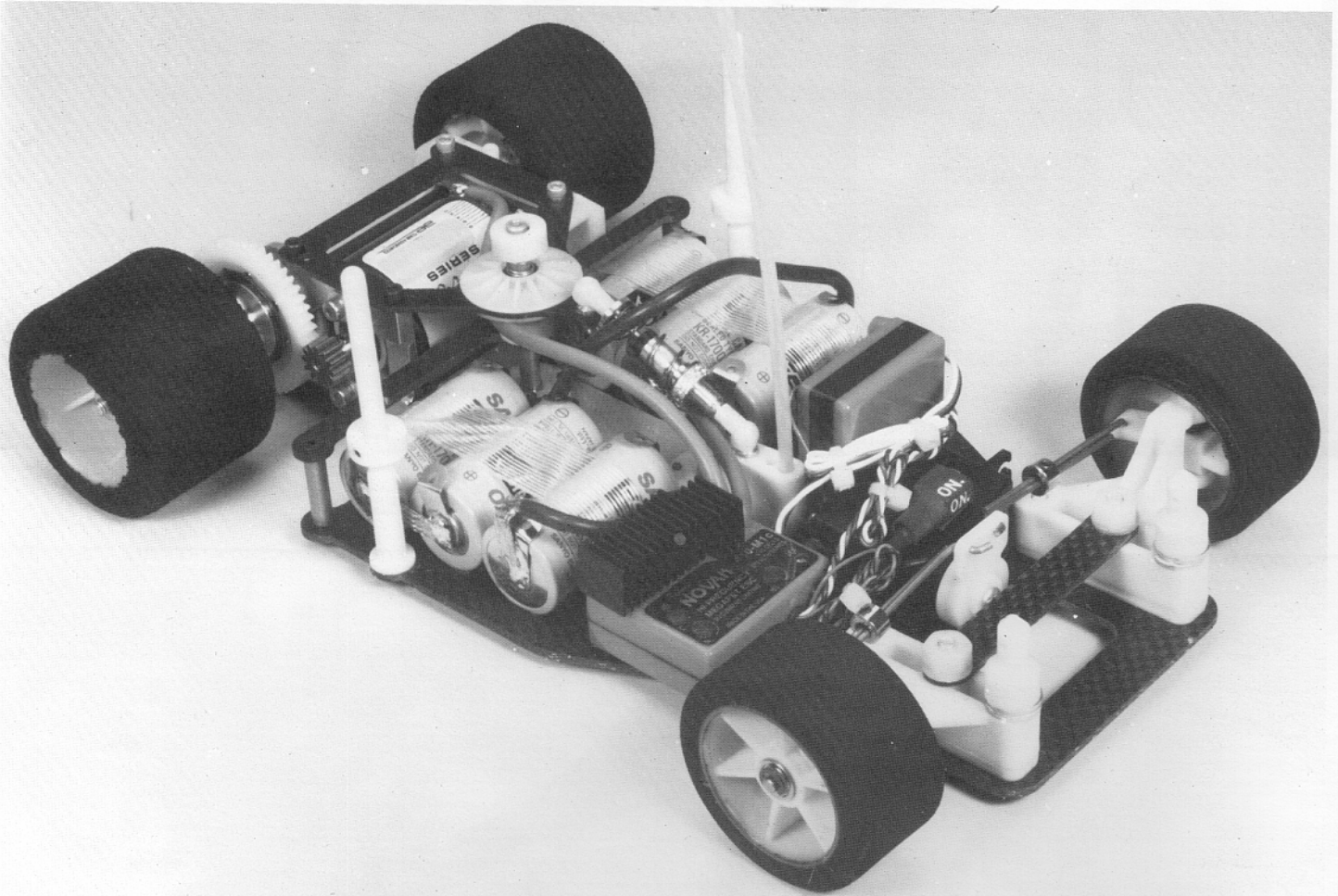


# RC12LW GRAPHITE



## CAUTION

Ni-Cd batteries are susceptible to damage when overcharged at a high rate, and can release caustic chemicals if the overcharge is severe. **Read the battery charging instructions in this manual before attempting to run your car.**

Do not stall the motor under power. If the car stops suddenly on the track, or fails to move forward when you attempt to accelerate (after hitting a wall, for instance), push the throttle control on your transmitter to the brake position immediately and attend to the car. A small rock may have stalled the gears, and if the throttle is left in the "on" position, the result can be a burned-out motor or resistor or electronic speed control unit.

If you run your car to the point where more than one cell in the pack is completely discharged, **it is possible to lose radio control of the car** before the drive motor stops completely. For this reason you should not operate your car in an area where it could be damaged or cause harm to others, such as near a pool of water or a busy roadway. Usually radio control will be regained as soon as you pull the car from the obstruction and the motor is allowed to free-run. If you still don't have control, then you should turn the switch off.

A partially burned-out or shorted motor can make the car appear to have radio problems. If the car slows down suddenly and the radio acts erratically even with a full battery charge, then the cause is probably the motor. Check the range of the radio. A shorted motor will draw extremely high current even under no-load conditions.

RC12LW is a trademark of ASSOCIATED ELECTRICS, INC.  
©1991 ASSOCIATED ELECTRICS, INC.

# FIRST, A WORD

CONGRATULATIONS!! You now have the best 1/12 scale car in the world! The RC12LW has followed along in the winning tradition of all Team Associated 1/12 race cars. Starting with the original RC12E, which won numerous National Championships, Associated then designed the RC12i, which won the very first 1/12 IFMAR World Championships in Anaheim, California, and then again won the next World Championships in Denmark. The RC12L followed in this winning tradition by taking 1st, 2nd, 3rd and 5th at the World Championships in Las Vegas, Nevada, including Top Qualifier honors.

The original design of the RC12L came from Gil Losi Jr.. Gil built the first prototype cars and proved their racing ability. With Gil's participation, Associated further developed the car. The new RC12LW was basically named by our Team that raced the car at the IFMAR World Championships in Singapore. The racers called it the WORLD'S car, hence the official designation RC12LW, or World's car for short.

The new RC12LW varies from the original RC12L in the placement of the weight in both cars. The RC12LW has had the battery weight moved closer to the centerline of the chassis and/or car which results in a car with more responsive steering, which is most apparent in the "S" sections of tracks. This necessitated a redesign of half of the parts of the car, as well as adding a shock absorber.

Did this help the handling of the car? Our Team told us it was a lot better and then went out and took 1st, 2nd and 3rd, as well as Top Qualifier honors, at the IFMAR World Championships in Singapore. You have the best car in the world.

# CHASSIS PREP

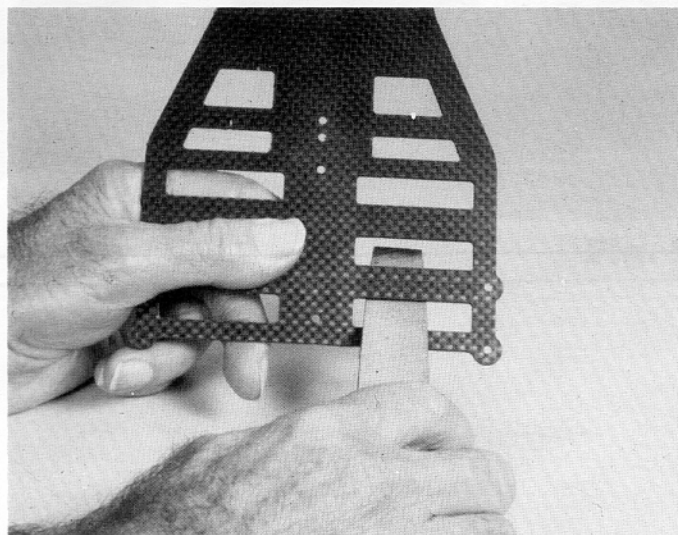
**Fig. 1**—There are two RC12LW kits made, the #4405, which is a fiberglass chassis kit, and the #4406, which is a graphite chassis kit. Those of you who have the fiberglass chassis can always update to the graphite chassis at a later date. The chassis are fully interchangeable.

Although these instructions show only the graphite chassis (the black chassis), the fiberglass car is assembled in exactly the same way these instructions show.

To begin, take your chassis, graphite or fiberglass, and notice that the BOTTOM of the chassis has the holes countersunk for screw heads. On the TOP of the chassis we want to file the eight battery slots at the small angle Fig. 1 shows so the battery cells will not be against a sharp corner that could possibly cut through the battery sleeve. Lightly file both sides, front and back, of all eight slots so the battery cells have a flat surface to seat against. (Fig. 79 shows how the cells are seated in the chassis.) You'll also want to file the edges of the chassis where the strapping tape holding in the batteries touches the chassis. Just round these corners so they can't cut the tape.)

When you're finished, wash off the chassis with running water and dry it with paper towels, and then wash your hands off with soap and water. Dispose of all the filings.

You're now finished with Fig. 1, so put a check mark in the box next to "Fig. 1" to show this step is completed. After you've completed each step from now on, check off its box so you know which part of the assembly is completed. You won't miss any steps this way.



**Fig. 1**

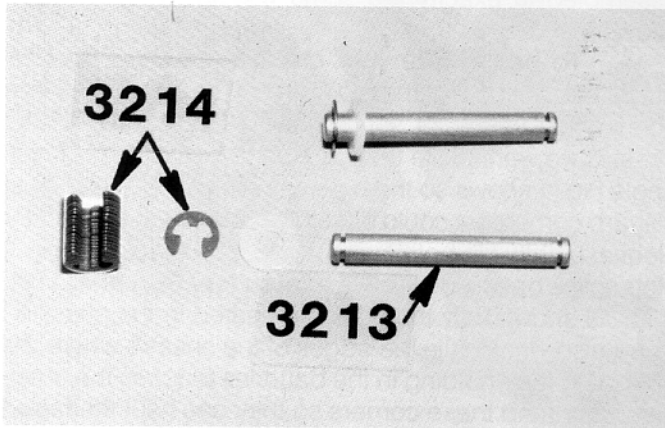
## SAVE THIS BOOKLET!

MORE THAN AN INSTRUCTION MANUAL, IT'S ALSO A HANDY, PICTORIAL SUPPLEMENT TO TEAM ASSOCIATED'S 1/12 SCALE CATALOG.

REFER TO THIS MANUAL FOR PART NUMBER AND NAME WHEN ORDERING.

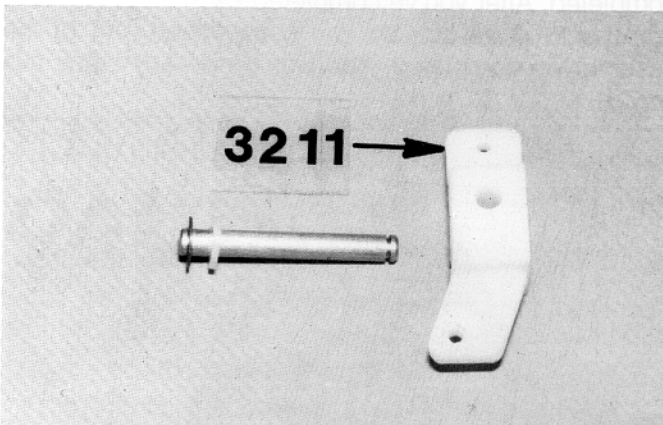
## FRONT END

□ **Fig. 2**—Empty Bag #1 into a paper plate. Take one of the #3213 front axles and push in one of the #3214 E-clips into the axle groove. (The E-clips are taped together and can be seen a little better in the photo.) Put another clip on the other axle. Now slip one of the small white nylon washers all the way onto the axles and up against the E-clip.



**Fig. 2**

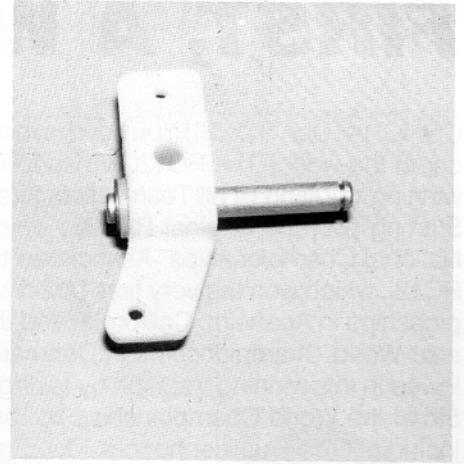
□ **Fig. 3**—The axles should now look like this.



**Fig. 3**

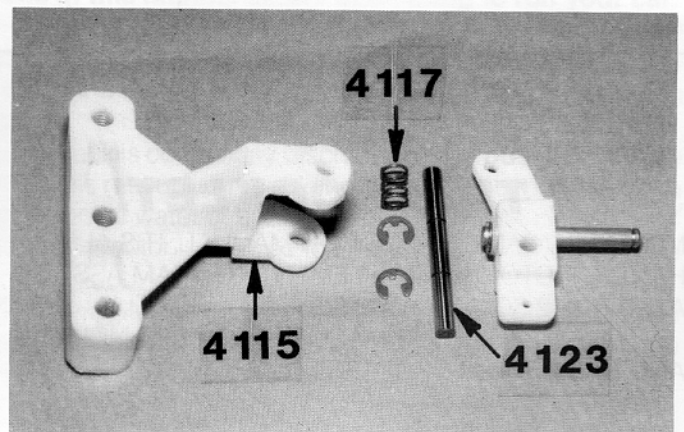
□ **Fig. 4**—

Now tap the axles into the #3211 front steering blocks in the direction shown. The axle will go in tight, so support the steering block before driving the axle in. Support it by using a board with a small hole in it, or a vise. Set the block on top of the vise and drive the pin downward through the slightly opened jaws. Assemble both blocks. Your front blocks so far should look as shown.

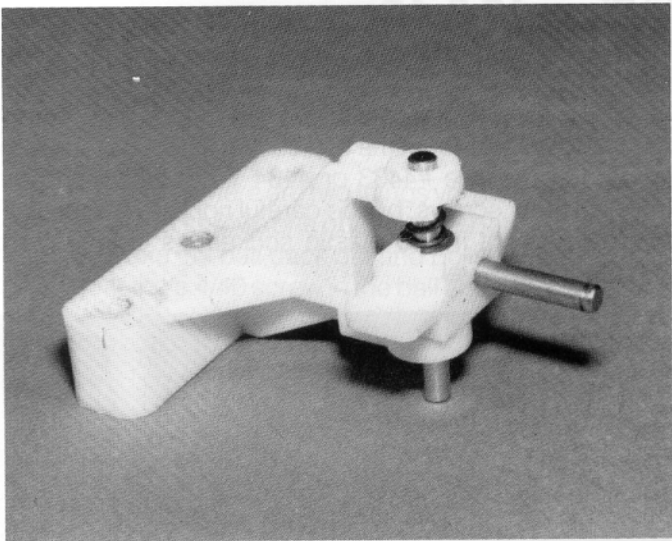


**Fig. 4**

□ **Figs. 5 & 6**—Now we're going to join the steering block to the #4115 front suspension arms. Place the steering block in the arm as shown in Fig. 6; place a spring on top of the arm where shown. Slide the #4123 kingpin into the suspension arm holes through the steering block and spring. Now put an E-clip into each of the two grooves in the kingpin. It's easier to put the clip in the groove by the spring first, and then to put the clip on the bottom of the steering arm last. It will be a close fit but they will go on. Pushing them in with a small screwdriver seems to work best. Assemble both blocks. Make sure they're securely in the grooves.



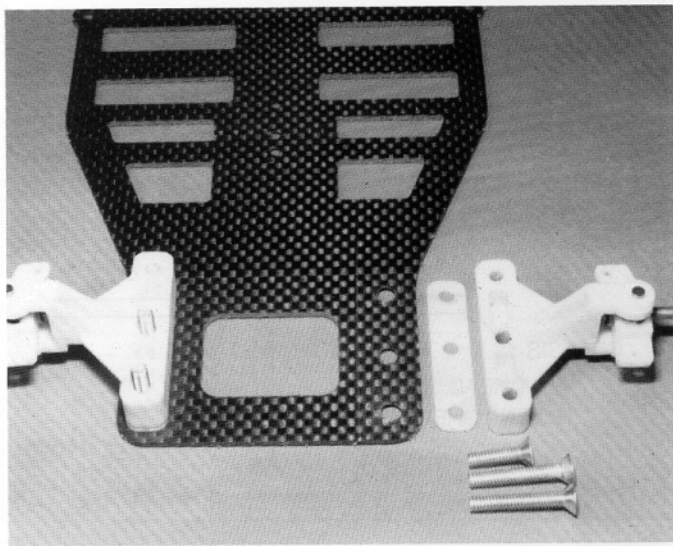
**Fig. 5**



**Fig. 6**

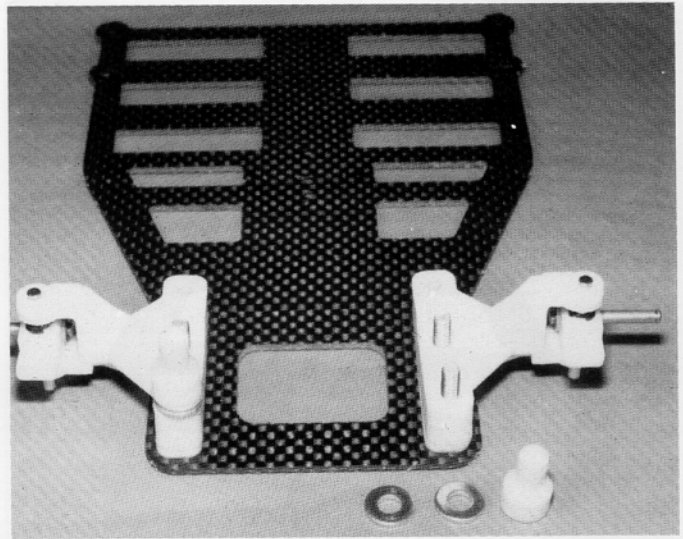
□ **Fig. 7**—Now we mount the suspension arms to the chassis. The spacer goes on the chassis first, then the castor shim goes on (not shown in photo), and then the suspension arm goes on top of the shim. Make sure you've got the left hand side of the arm on the left hand side of the car and right hand side arm on the right side.

Use three aluminum screws to mount each arm. Screw in and tighten the screws.



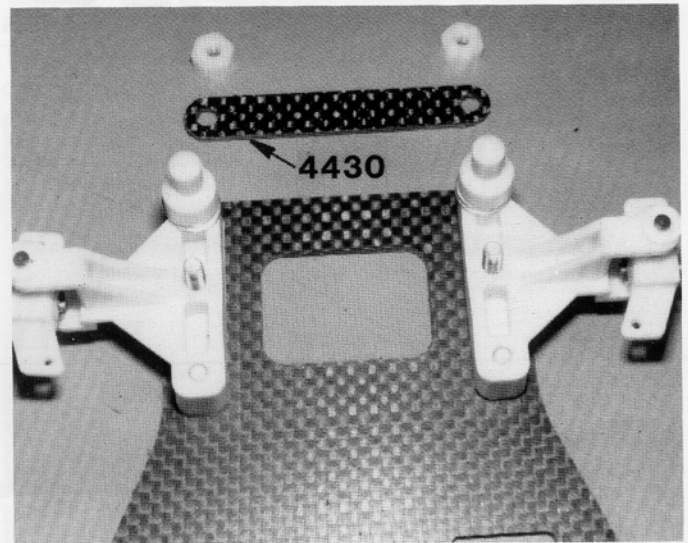
**Fig. 7**

□ **Fig. 8**—Open Bag #2. Mount the front body mounts onto the front screws. The height of the body mounts can be adjusted by washers according to the body you're using.



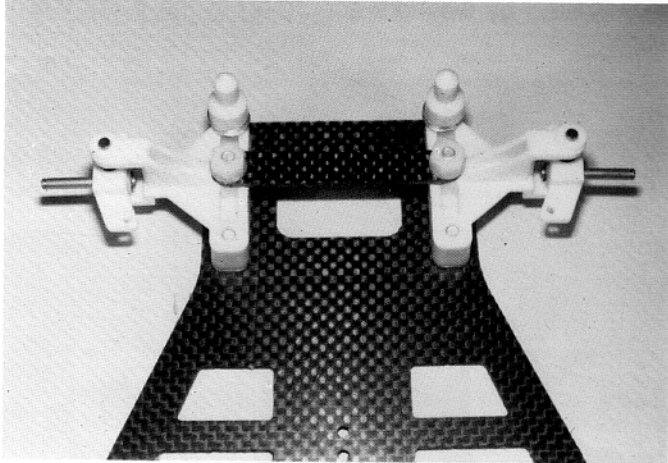
**Fig. 8**

□ **Fig. 9**—Now mount the #4430 suspension arm brace to both suspension arms using the nylon nuts. Do not overtighten the nylon nuts.

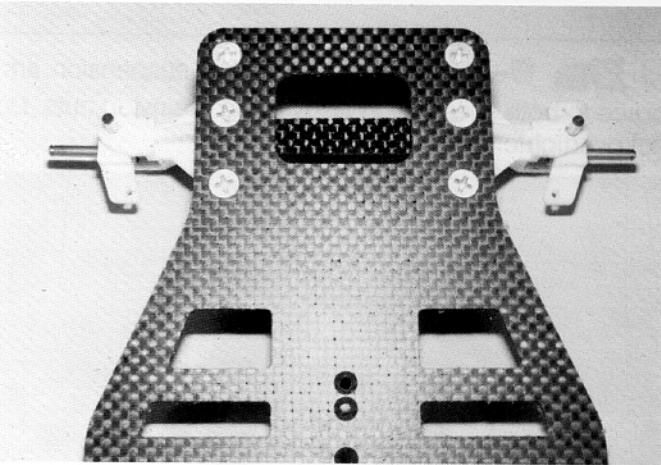


**Fig. 9**

□ **Figs. 10 & 11**—Your front end should now look like this.

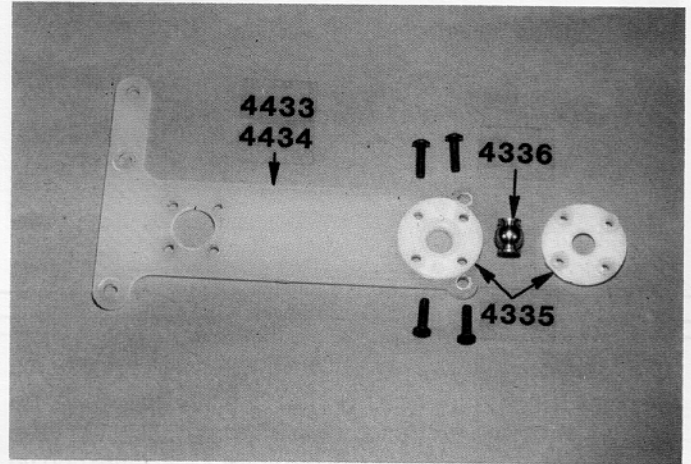


**Fig. 10**

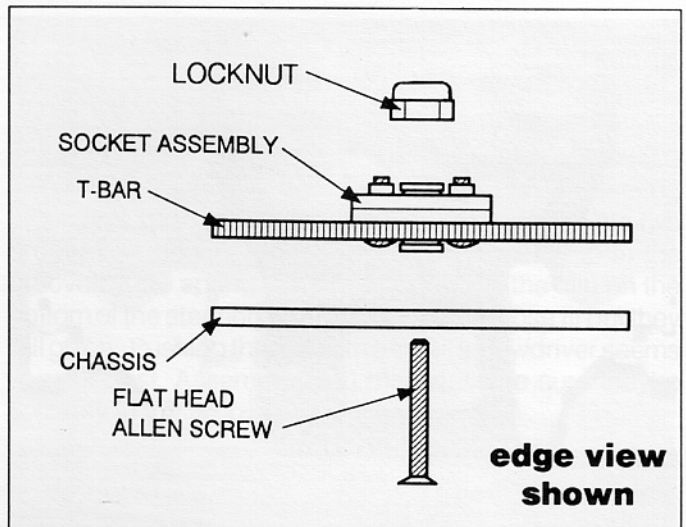


**Fig. 11**

□ **Figs. 12 & 12a**—From Bag #3 take the #4336 steel pivot ball and the #4335 plastic pivot socket and place the ball in one side of the socket, and then place the other half of the socket onto the ball and align all four screw mounting holes. Mount the ball socket assembly onto the forward end of the #4433 or 4434 T-bar where shown. Install the four screws, but be careful not to overtighten. If this ball is tight in the plastic socket, it's okay, it isn't supposed to swivel.



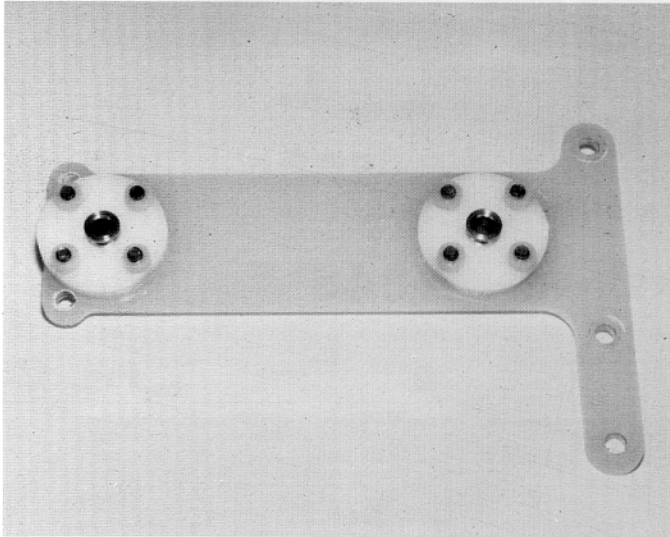
**Fig. 12**



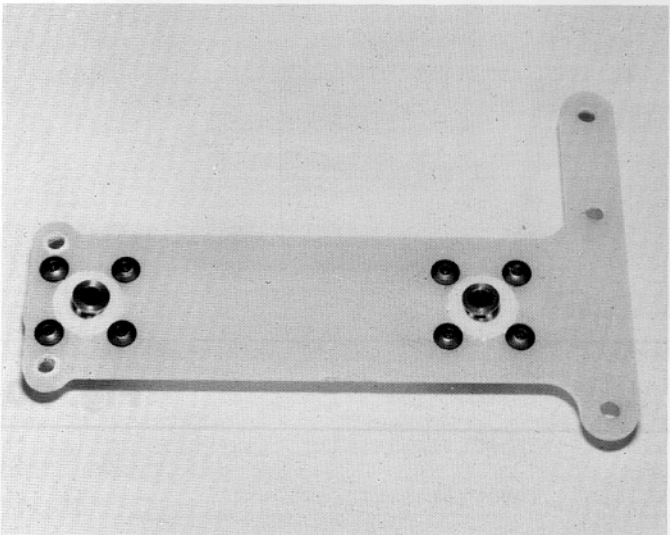
**Fig. 12a**

□ **Figs. 13 & 14**—Now assemble and mount the second rear socket assembly like you did the first one. Except in this socket, the ball **MUST BE VERY FREE, BUT NOT LOOSE**. Now see if the ball is **PERFECTLY FREE**. If it is, good, leave as is.

If it's not, there are two things you can do. You can unscrew all four screws one quarter turn. But the best thing to do is to take the ball back out and polish it. You can do this by placing a 4/40 screw in the ball and securing it with a nut and turning the screw in a drill press, polishing the ball with crocus cloth or #660 wet or dry sandpaper. Re-install the ball and make sure it's **PERFECTLY FREE**, but **NOT LOOSE**.

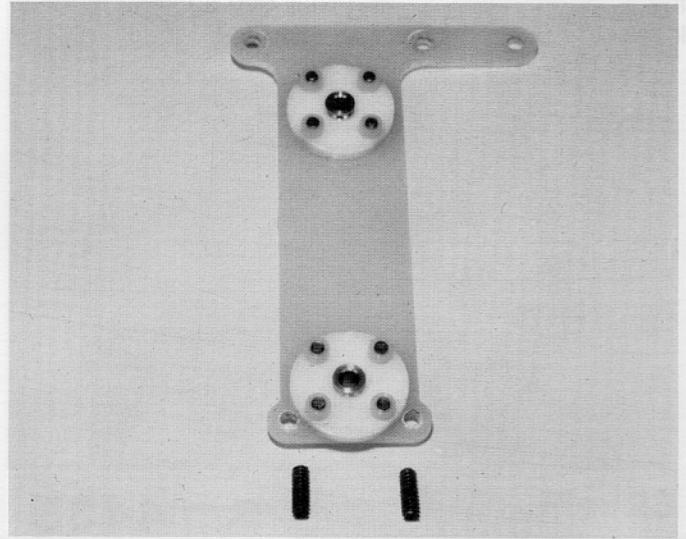


**Fig. 13**



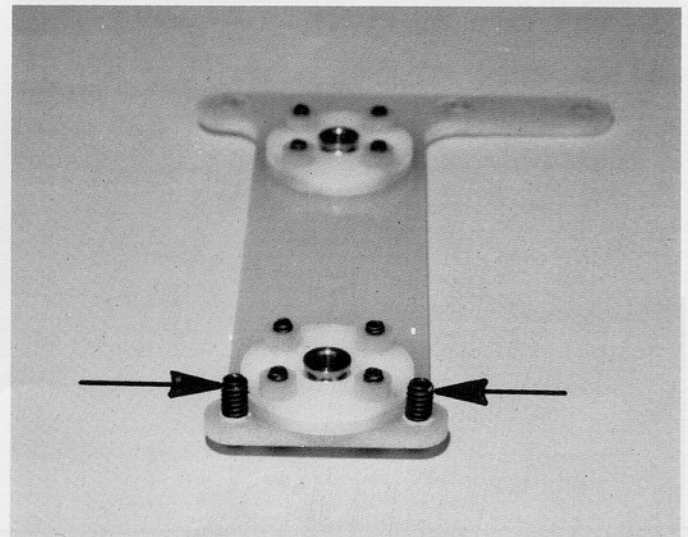
**Fig. 14**

□ **Fig. 15**—Install the two long set screws into the top of the T-bar where shown. Just screw them in far enough so they just start to come through the bottom side, but **NO MORE**.



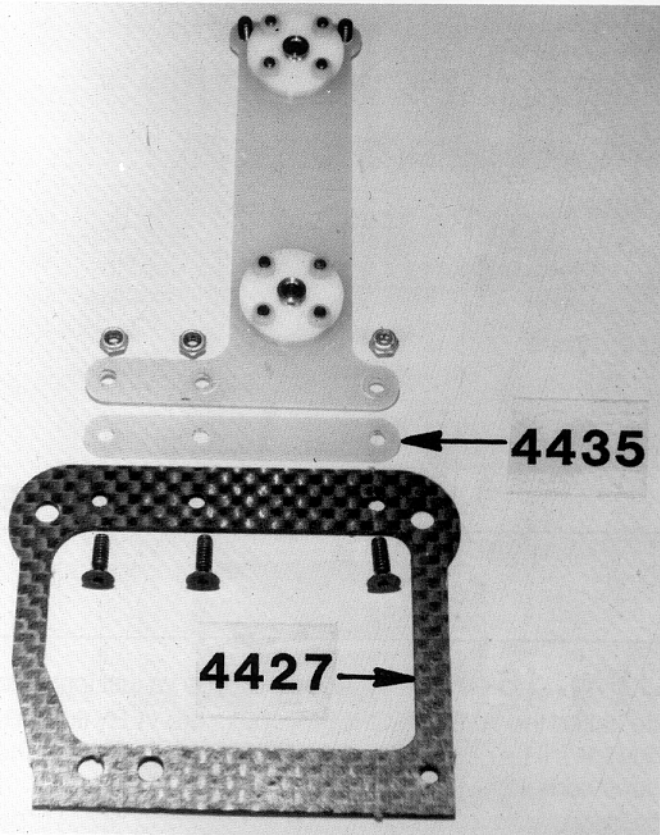
**Fig. 15**

□ **Fig. 16**—The two set screws you've just installed are called the **TWEAK SCREWS**. These are **VERY IMPORTANT**. We'll be coming back and adjusting these after the car is completely assembled.

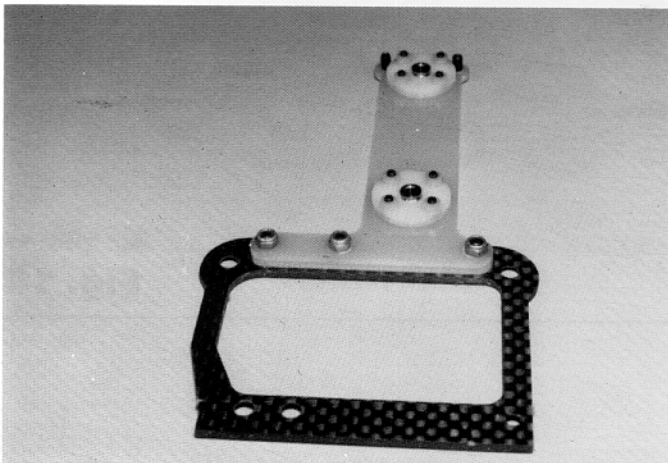


**Fig. 16**

□ **Figs. 17 & 18**—Install the T-bar assembly on top of the #4427 lower brace as shown. Push the three flat head screws up through the bottom of the lower brace and then slip the spacer down onto the three screws. Then slip the T-bar onto the screws. Install and tighten the three locknuts.



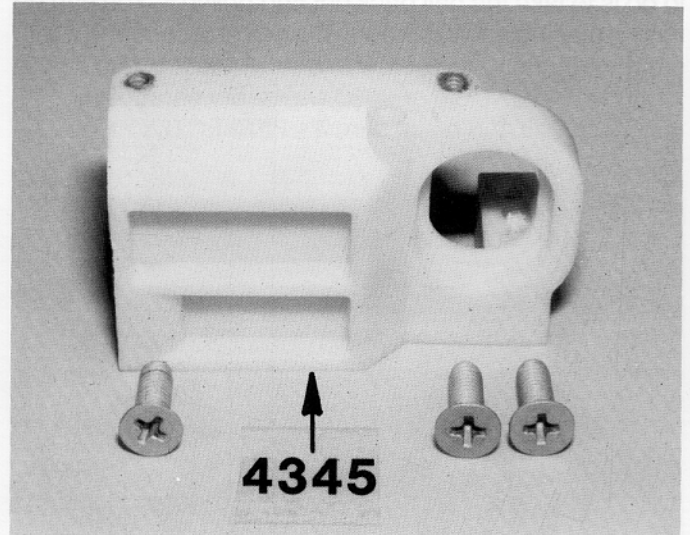
**Fig. 17**



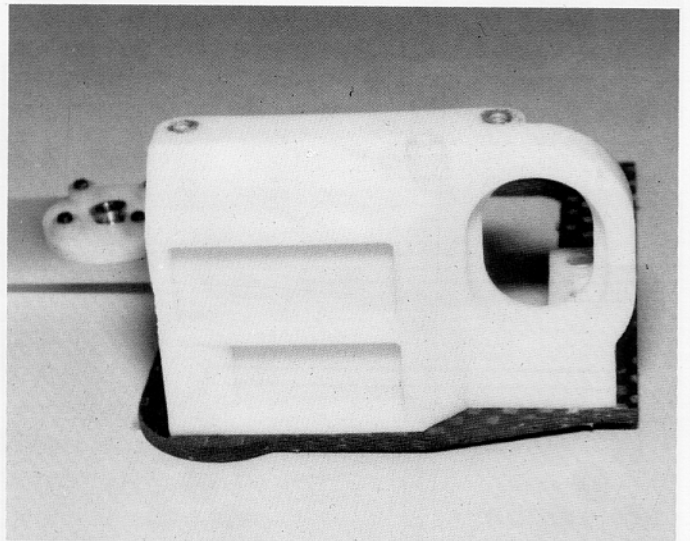
**Fig. 18**

## REAR END

□ **Figs. 19 & 20**—Open Bag #4. Install the left hand #4345 bulkhead onto the lower brace with the three flat head aluminum screws as shown. Do not overtighten.

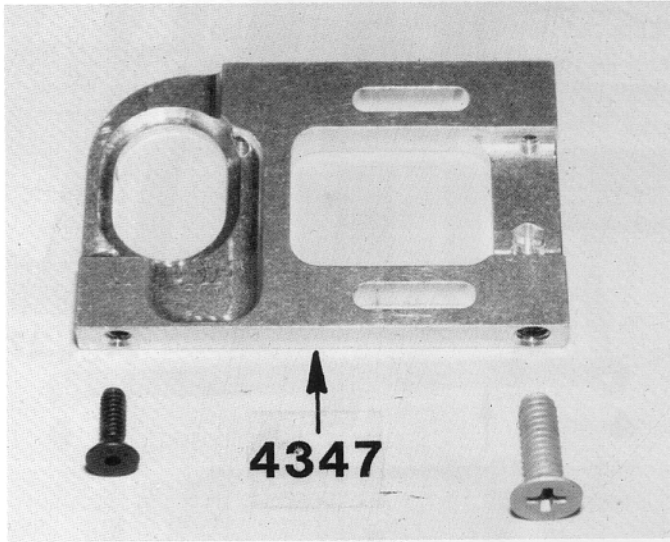


**Fig. 19**

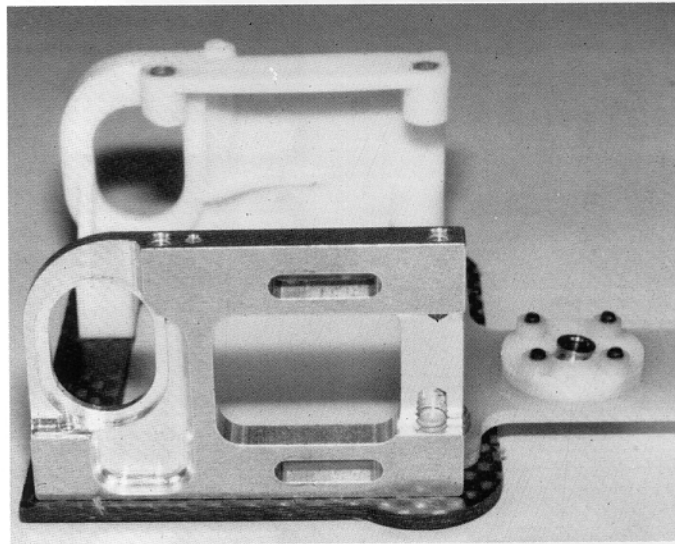


**Fig. 20**

□ **Figs. 21 & 22**—Install the right hand #4347 aluminum bulkhead onto the lower brace as shown. If you have the fiberglass kit, install the right hand #4346 plastic bulkhead with the three aluminum screws.

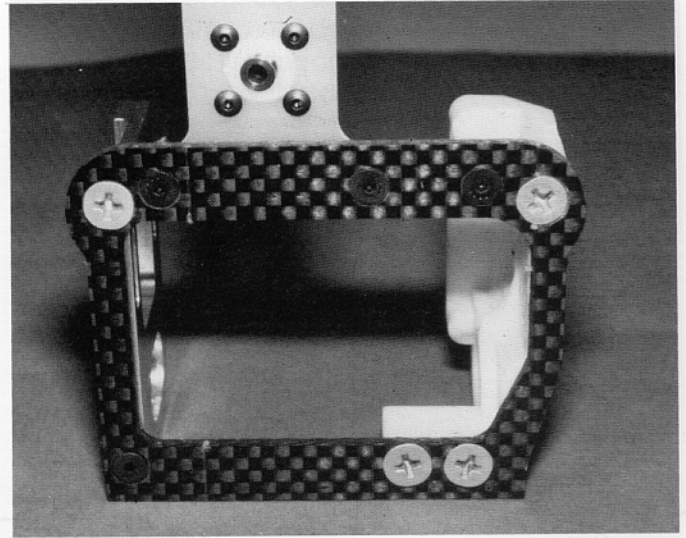


**Fig. 21**



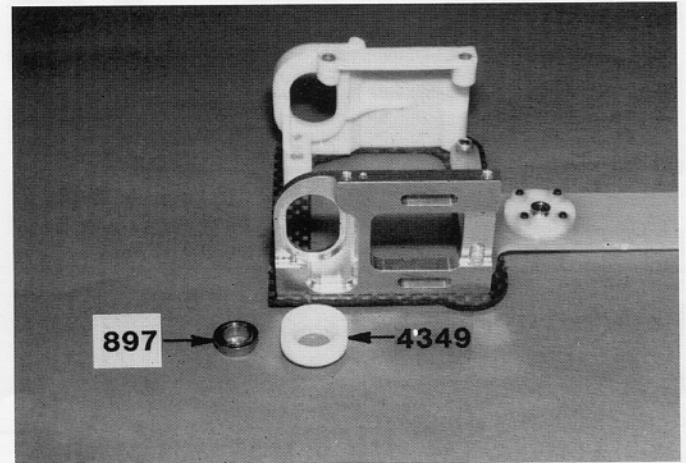
**Fig. 22**

□ **Fig. 23**—The bottom of the rear end assembly should look like this now.



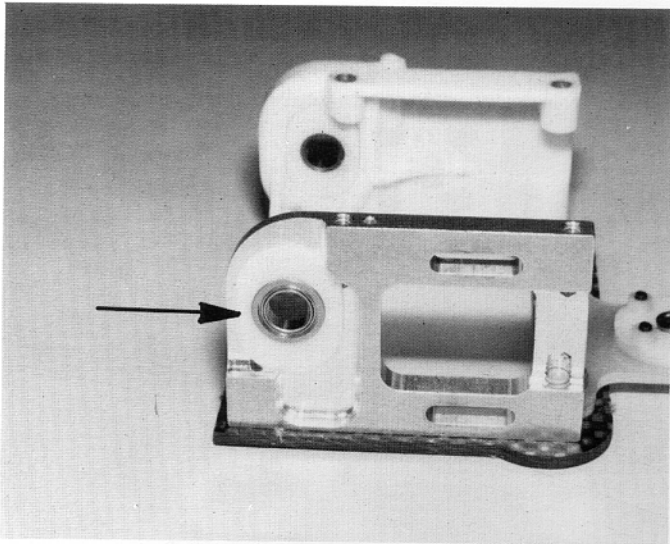
**Fig. 23**

□ **Figs. 24 & 25**—Take the #4349 plastic axle bearing height adaptors, the ones with the ball bearing holes centered in the adaptor, and install the adaptors in the left hand and right hand bulkheads, as shown. Now install a #897 ball bearing in each adaptor.



**Fig. 24**

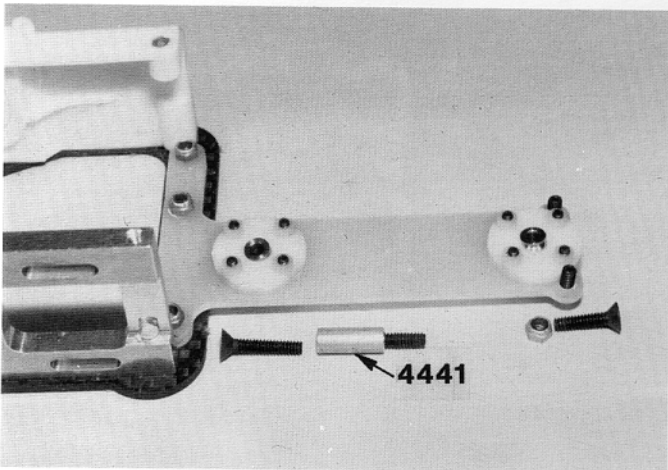




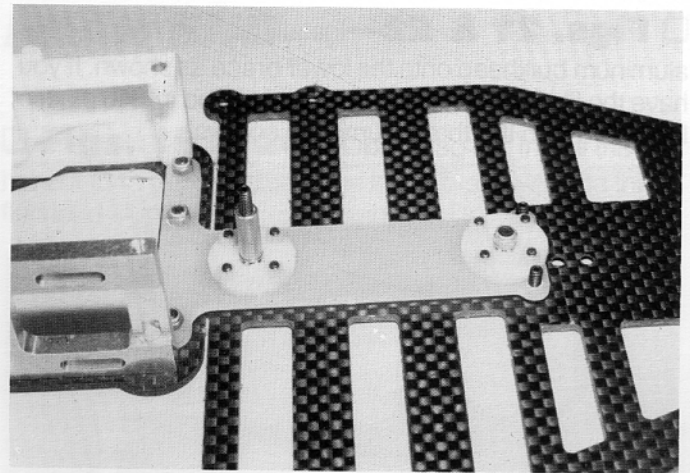
**Fig. 25**

□ **Figs. 26, 27 & 28**—Now we're ready to install the rear end assembly onto the chassis. Slip the short screw up through the forward hole in the chassis, then slip the T-bar down onto the screw, install and tighten the locknut.

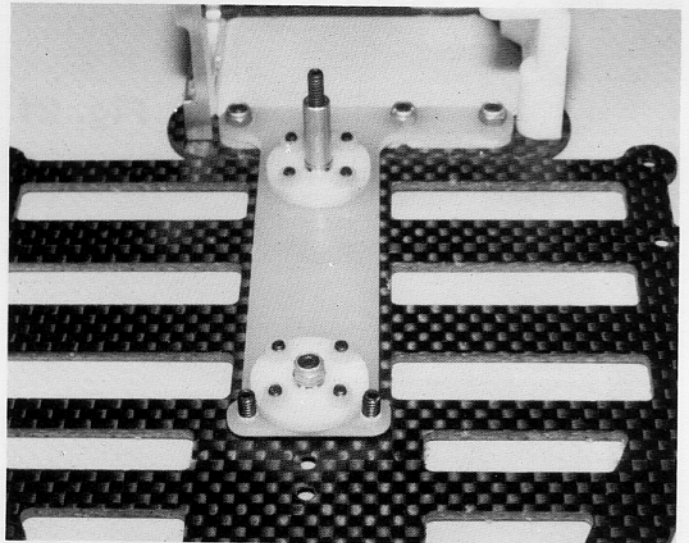
Slip the long screw up through the chassis and the rear ball, thread the shortest aluminum tube down onto the screw, and tighten the screw. Now screw a little less than 1/2 of the set screw into the tube.



**Fig. 26**



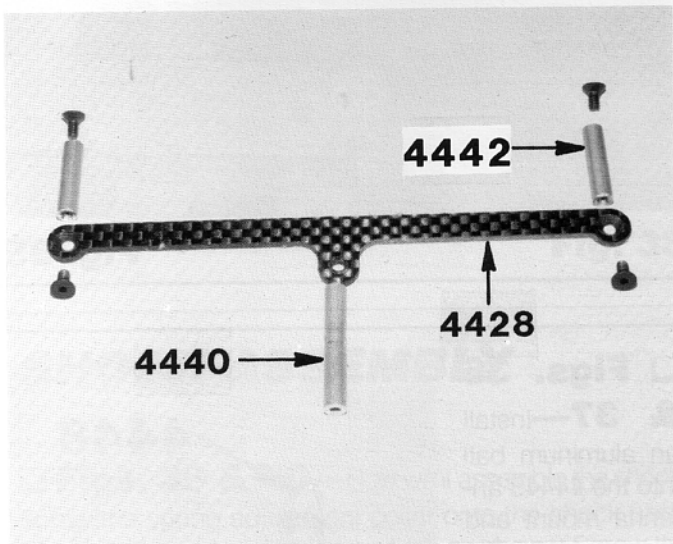
**Fig. 27**



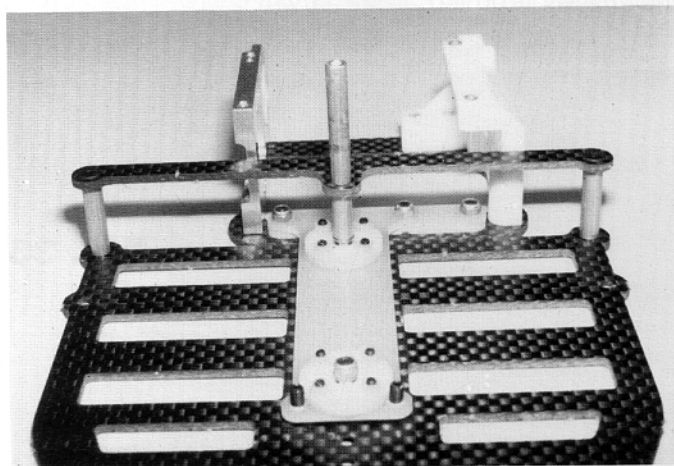
**Fig. 28**

□ **Figs. 29 & 30**—Time to install the rear #4428 brace. Open Bag #5. Install the two #4432 aluminum tube spacers to the chassis with the two short flat head screws shown, but do not tighten the screws yet.

Slip the brace down over the long set screw with the countersunk side up and then install the two short screws in the outer ends of the brace. Tighten all four screws now. Slip the longest aluminum tube onto the long set screw and tighten down with a pliers.

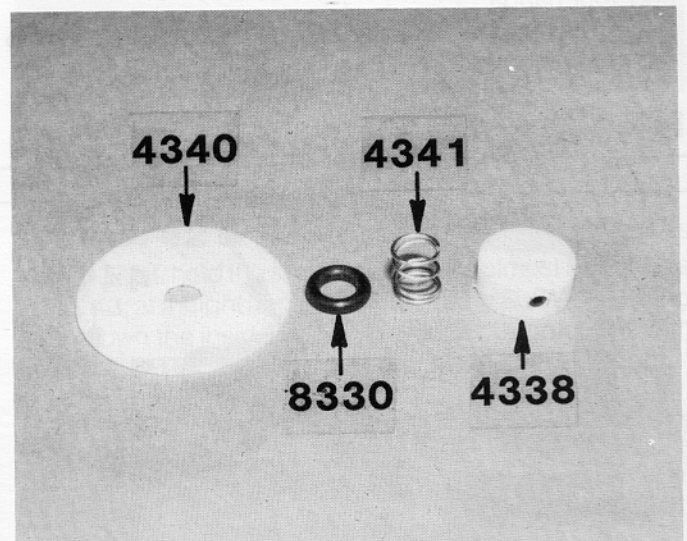


**Fig. 29**

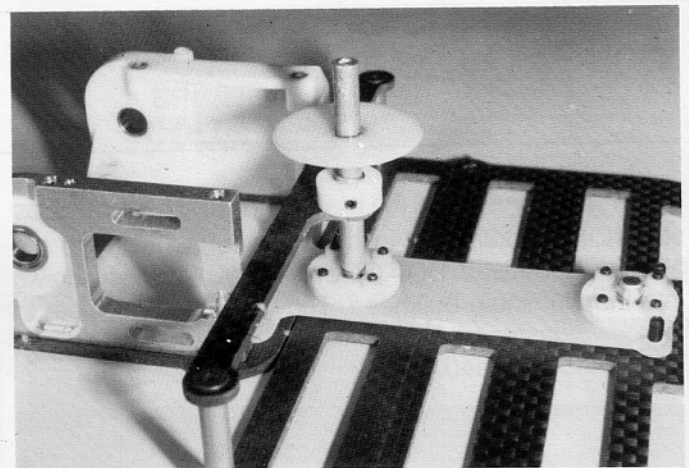


**Fig. 30**

□ **Figs. 31 & 32**—Open Bag #6. Take the #8330 black O-ring and push it into the hole in the #4340 dampner washer. Start a set screw into the #4338 locking collar and slip the collar down over the tube, as shown. Now slip the #4341 spring on and then the #4340 dampner washer with the smooth side of the washer up.



**Fig. 31**

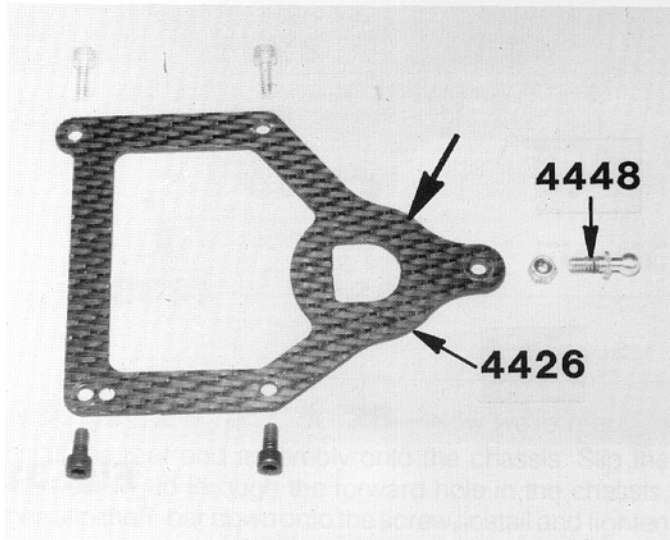


**Fig. 32**

□ **Fig. 33**—Take the #4426 upper bracket. The arrow is pointing where the dampner washers ride.

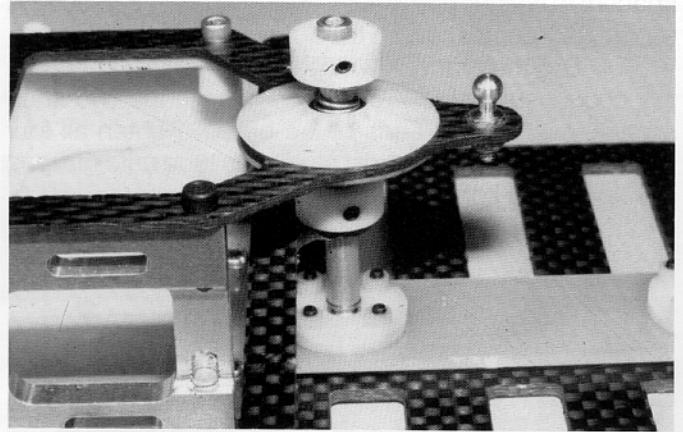
*Racer's Tip:* The Team racers will take some #600 grit wet or dry sandpaper and sand all the edges smooth here, so that the dampner washers slide freely over the bracket. Do this on the top and bottom. Clean the bracket and your hands.

Install an aluminum ball from Shock Bag #7 into the top of the bracket; tighten nut.



**Fig. 33**

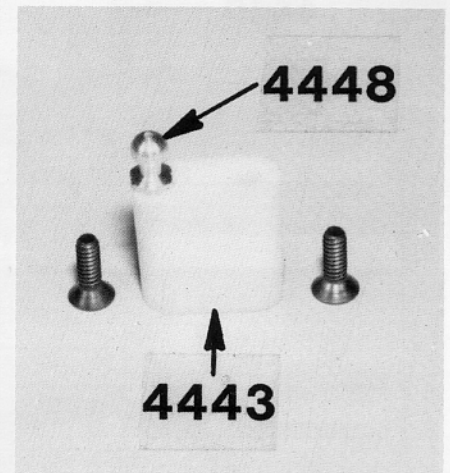
□ **Fig. 35**—Install the upper dampner washer assembly, as shown.



**Fig. 35**

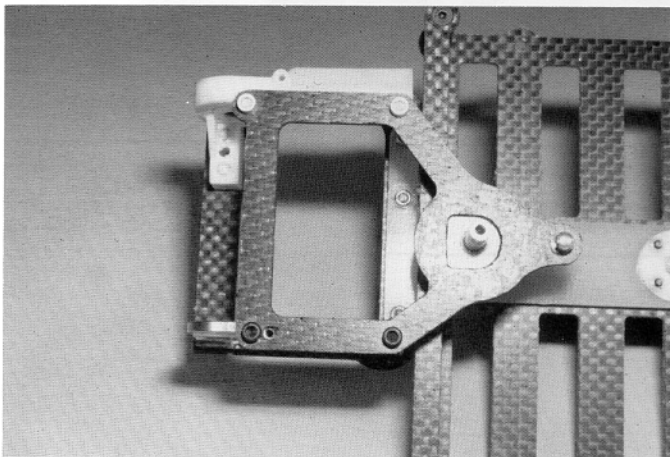
□ **Figs. 36**

**& 37**—Install an aluminum ball into the #4443 antenna mount and then install the antenna mount to the chassis.

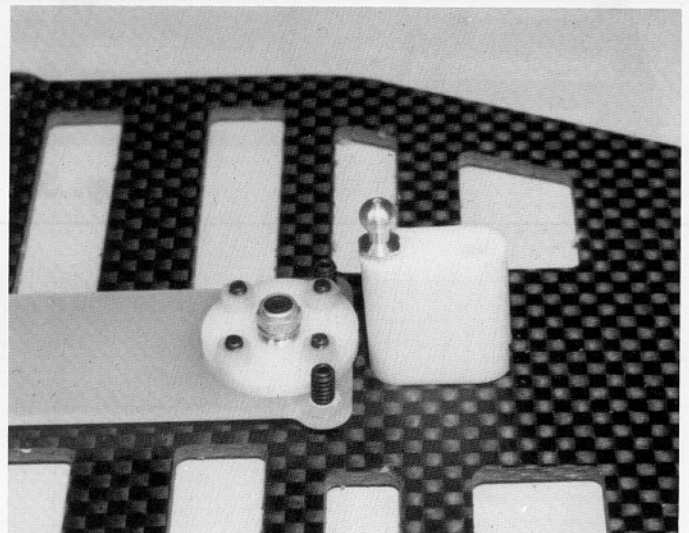


**Fig. 36**

□ **Fig. 34**—Install the bracket onto the bulkheads, as shown. Make sure you install the steel screws into the aluminum bulkhead. DO NOT ever install aluminum screws into the aluminum bulkhead. They will be impossible to remove or fasten securely. Install the aluminum screws in the plastic bulkhead. Do not overtighten.

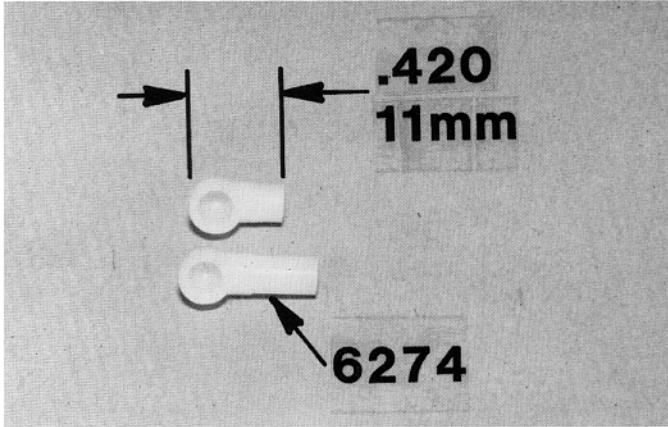


**Fig. 34**



**Fig. 37**

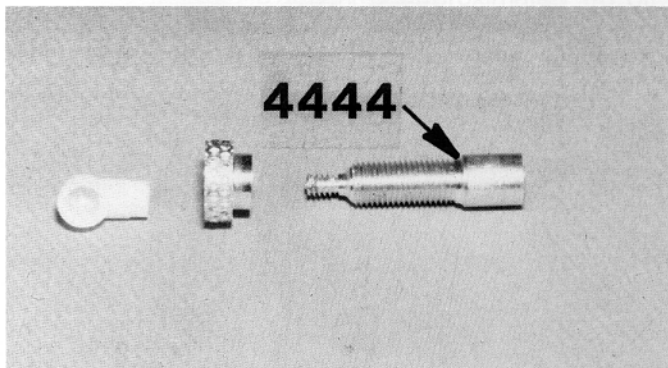
□ **Fig. 38**—Take the two #6274 plastic ball cups and shorten both with an Exacto knife to the dimension shown.



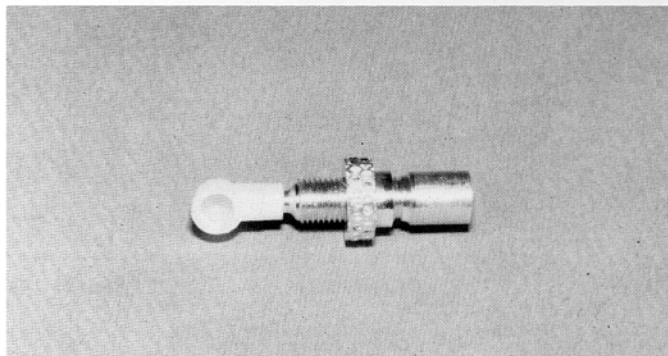
**Fig. 38**

## SHOCK ASSEMBLY

□ **Figs. 39 & 40**—Now we'll assemble the shock. Screw the spring adjustment collar onto the shock body with the stepped end going on first, as shown. Screw the collar all the way on until it bottoms out, and then back it off two full turns. Now screw the plastic ball up all the way onto the threads.

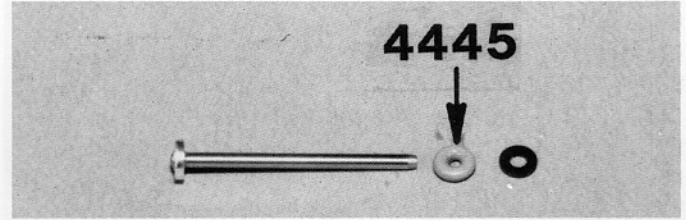


**Fig. 39**



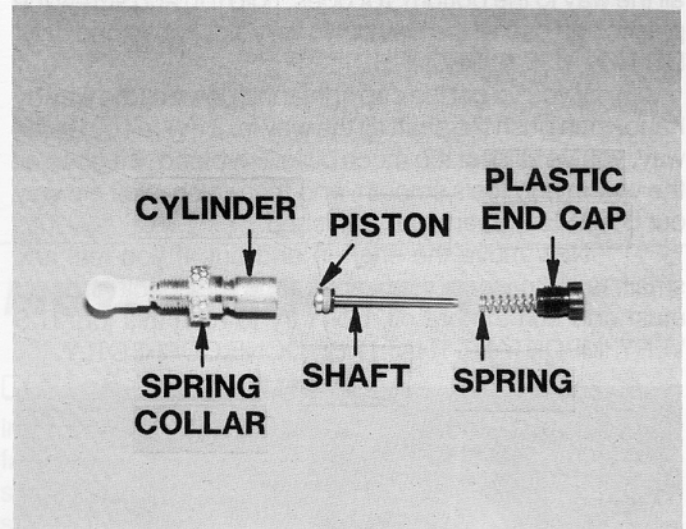
**Fig. 40**

□ **Fig. 41**—Slip the red O-ring onto the shock shaft and then slip the black plastic washer on.

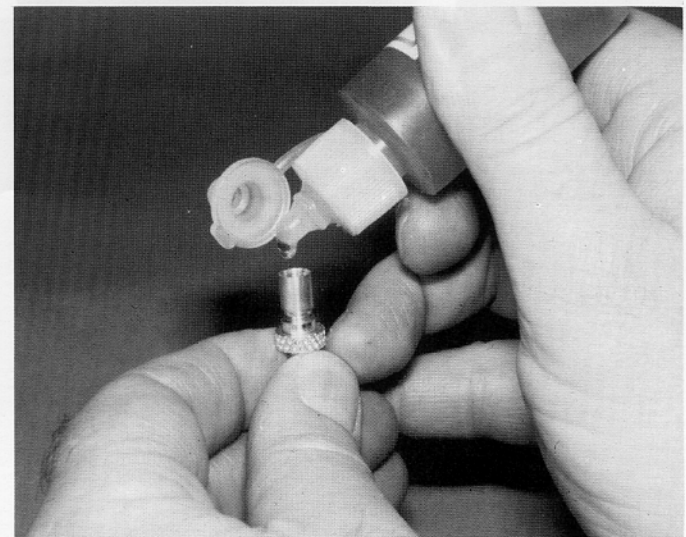


**Fig. 41**

□ **Figs. 42 & 43**—The parts go into the shock as shown. First, hold the shock body so it's almost upright, as in Fig. 43, at a slight angle. Put shock oil in SLOWLY, letting it run down the inside wall to prevent air bubbles. Fill with oil to the BOTTOM of the threads. Keep shock upright.



**Fig. 42**



**Fig. 43**

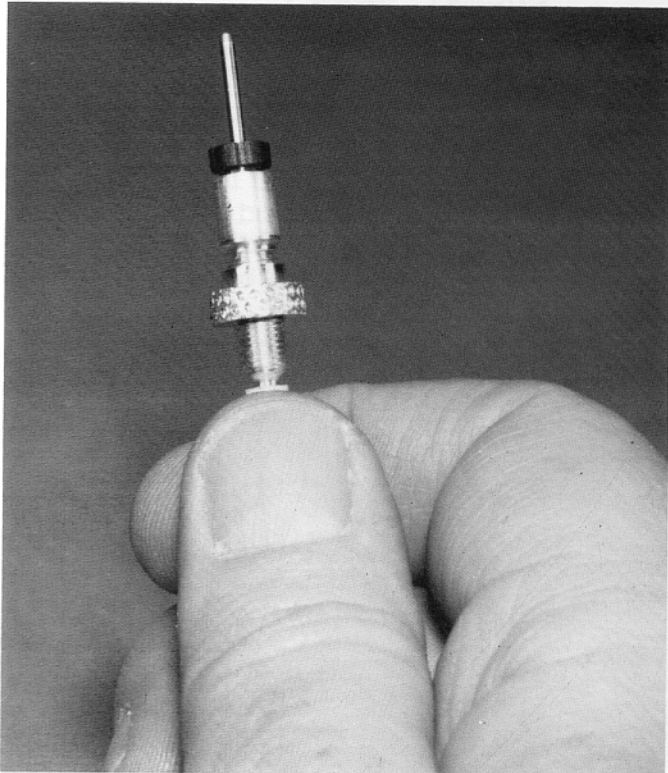
□ **Figs. 44 & 45**—Push the piston and shaft assembly slowly down into the cylinder. Trim the flash off of the plastic end cap. Now slip the spring and plastic end cap onto the shaft. BE CAREFUL HERE. Screw the plastic end cap only two turns into the cylinder, SLOWLY, as shown in Fig. 44.

Now we must bleed the shock. THIS IS A VERY IMPORTANT PROCEDURE. There's no quick, easy way. It'll take a few minutes. Refer to Fig. 45. Push the shaft in VERY SLOWLY. We want to be able to push it all the way to the bottom. However, if there's too much oil in it, the shaft will not go all the way to the bottom. If there's too much oil, unscrew the plastic end cap while pushing the shaft in. It might be necessary to bleed some of the oil out. We're talking about a very small amount of oil here. Less than a drop.

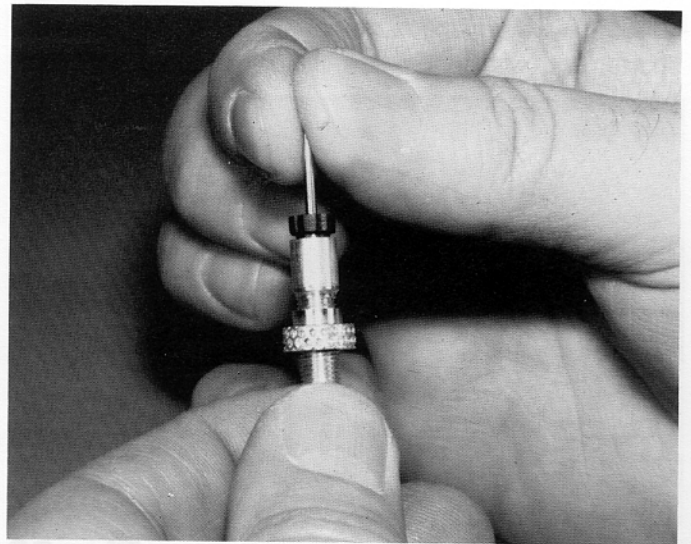
If you've unscrewed the cap all the way, then you can push the shaft all the way in, and now re-install the plastic end cap two turns. Push the shaft. See if it will go all the way to the bottom. If it does, hold it in and screw the plastic end cap all the way down very slowly by hand only. DO NOT USE A WRENCH.

If you've got the cap tightened down all the way by hand, then push the shaft all the way in. If it won't go all the way, you've still got too much oil in. Re-bleed. If it goes all the way in and feels smooth, and then pushes all the way out BY ITSELF, then you're finished.

Now move the shaft in and out. If you feel any small, jerky motions, you've got air in the shock and you must add some more oil. Don't try to rush this job. IT'S VERY IMPORTANT THAT IT BE DONE CORRECTLY.

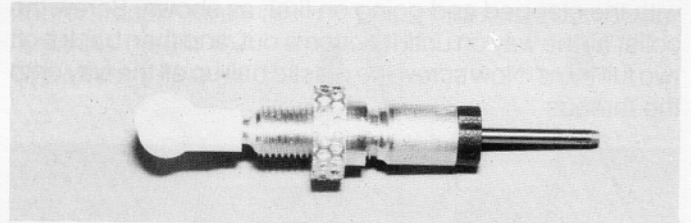


**Fig. 44**

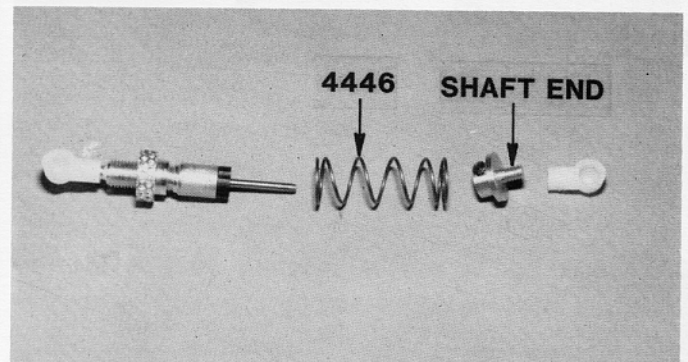


**Fig. 45**

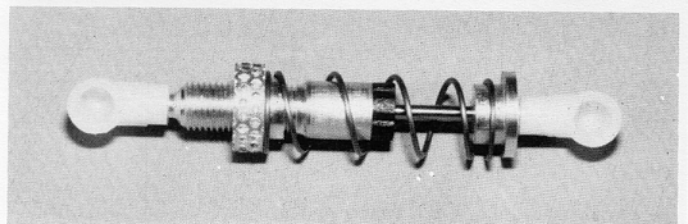
□ **Figs. 46, 47 & 48**—Put a set screw into the shaft end and screw the plastic ball cup all the way on. Slide the # spring onto the shock. While holding the spring collapsed, slip the shaft end onto the shock shaft and securely tighten the set screw.



**Fig. 46**

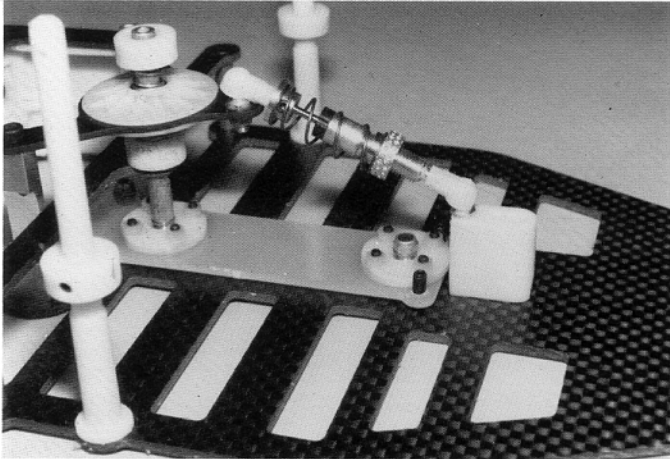


**Fig. 47**

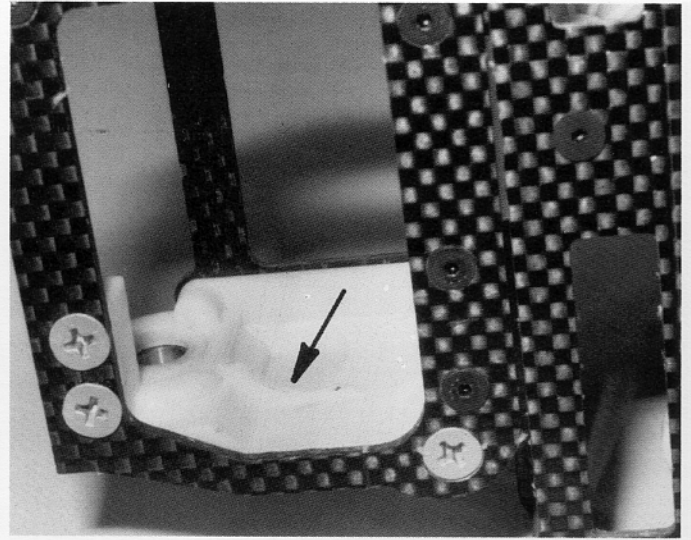


**Fig. 48**

□ **Fig. 49**—Snap the shock onto the ball ends as shown.

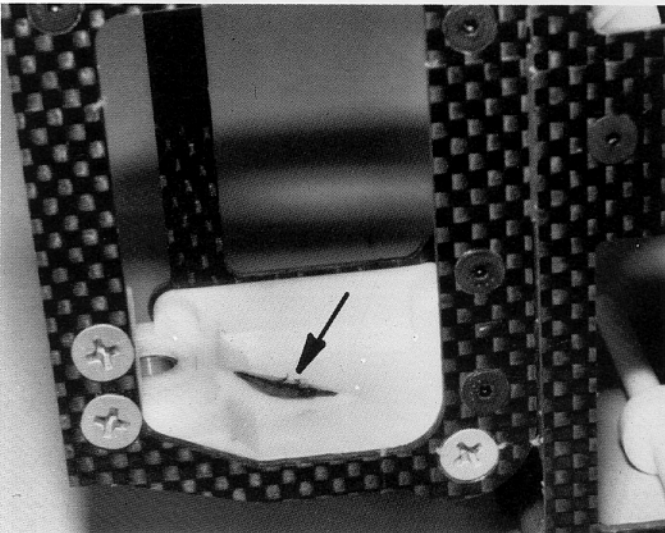


**Fig. 49**



**Fig. 51**

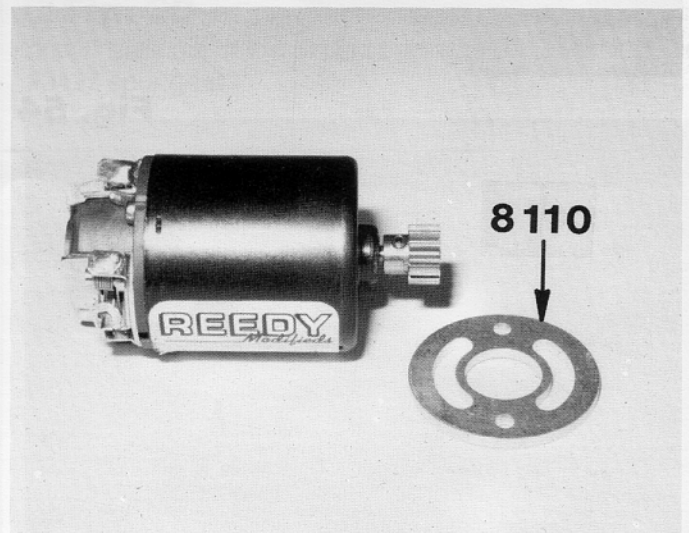
□ **Figs. 50 & 51**—We'll need to trim some of the plastic away on the left hand bulkhead where shown in Fig. 50. Use an Exacto knife and trim it approximately 1/8" off, as shown. It should now look like Fig. 51. This will allow us to install the motor much easier.



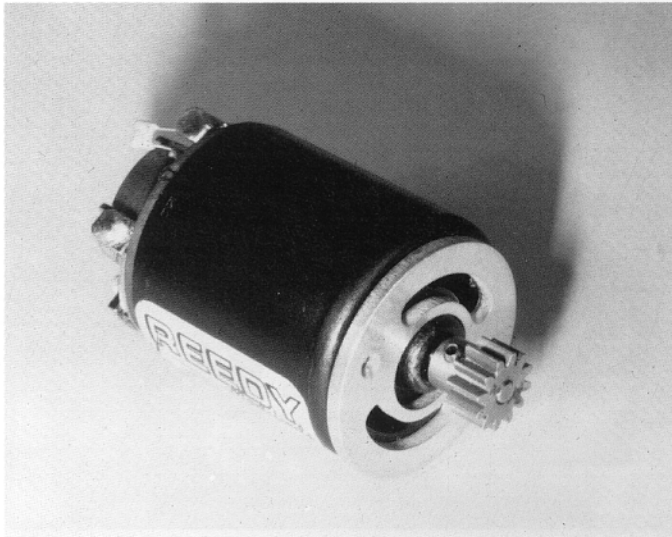
**Fig. 50**

## MOTOR MOUNTING

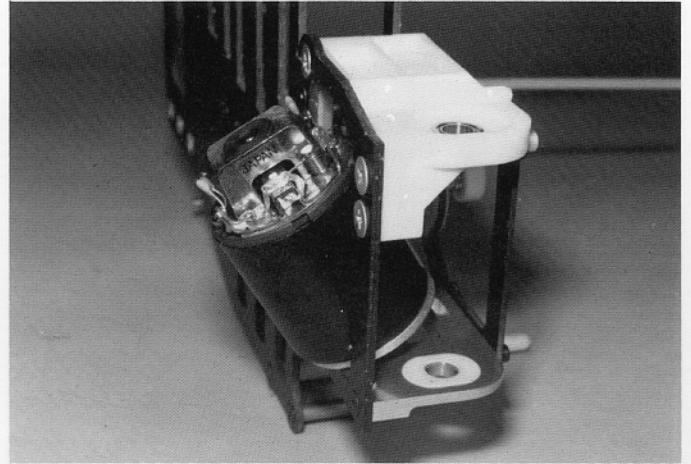
□ **Figs. 52 & 53**—Before you install your motor, install the capacitors onto the motor that the motor manufacturer recommends to prevent radio interference. Now set screw the motor pinion gear onto the motor shaft as shown so that the end of the pinion gear is flush with the end of the motor shaft. Now slip the #8110 motor spacer onto the motor.



**Fig. 52**

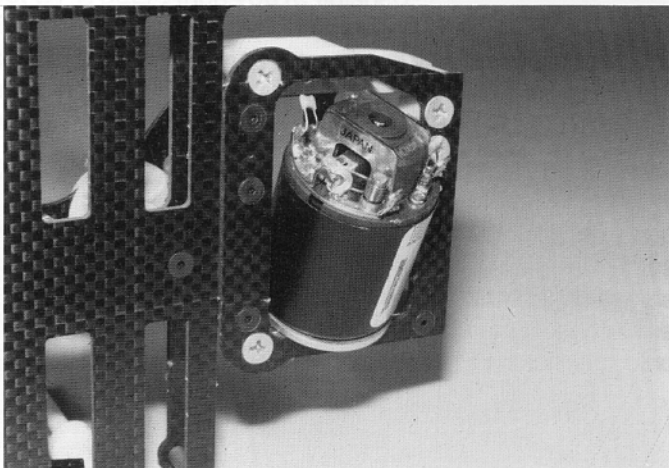


**Fig. 53**



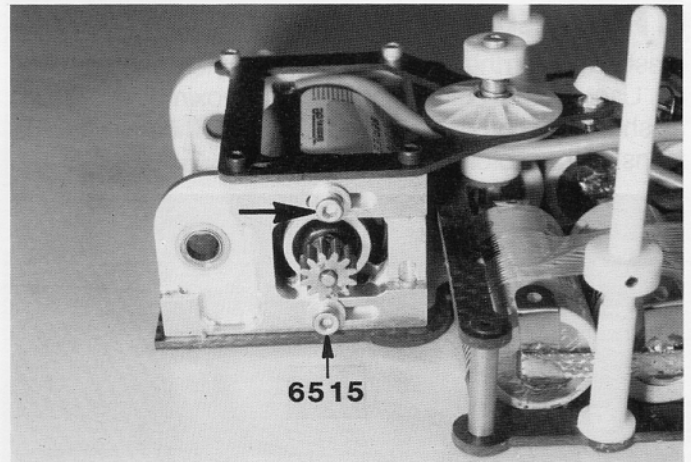
**Fig. 55**

**Figs. 54 & 55**—The motor is installed into the chassis through the bottom of the rear pod, as shown.



**Fig. 54**

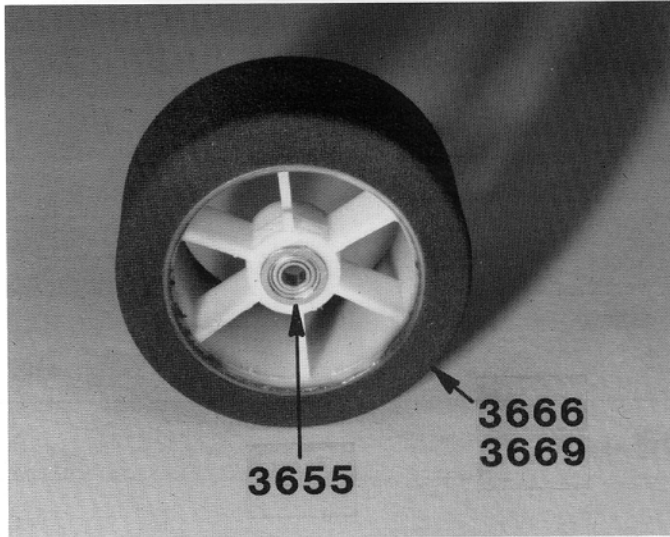
**Fig. 56**—Install a washer on each motor mount screw and install the two screws loosely. They'll have to be adjusted later.



**Fig. 56**

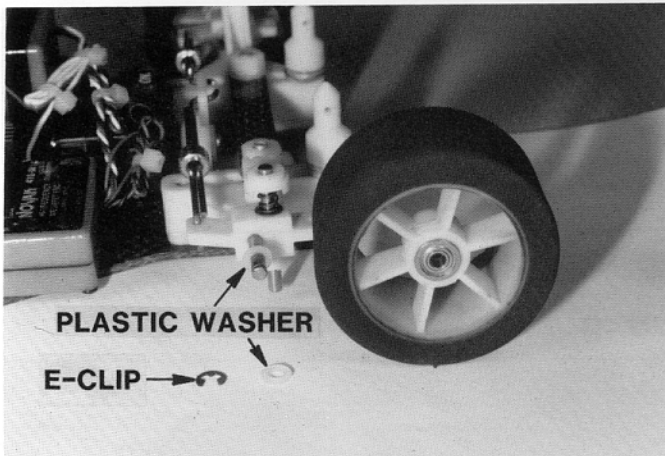
## FRONT WHEELS

□ **Fig. 57**—Take the front wheels and push a #3655 ball bearing into the inside and outside bearing pockets in each wheel.

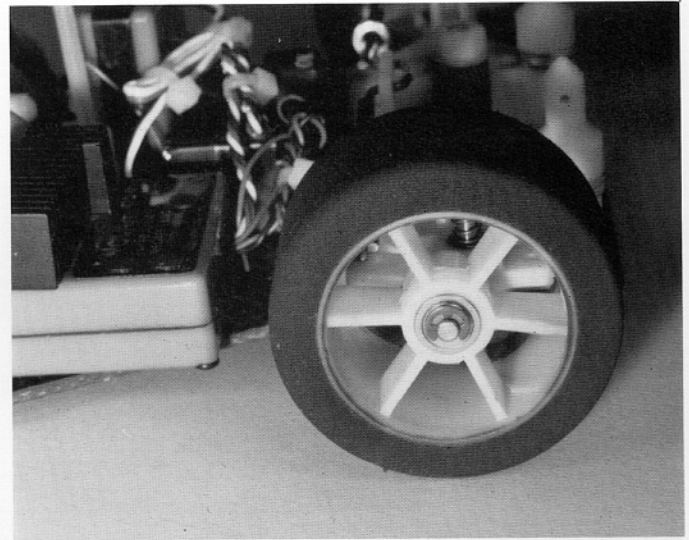


**Fig. 57**

□ **Figs. 58 & 59**—Slide a plastic washer onto the front axle, slide the wheel assembly on, then slide another plastic washer on, and install the E-clip. Make sure the E-clip is fully seated.



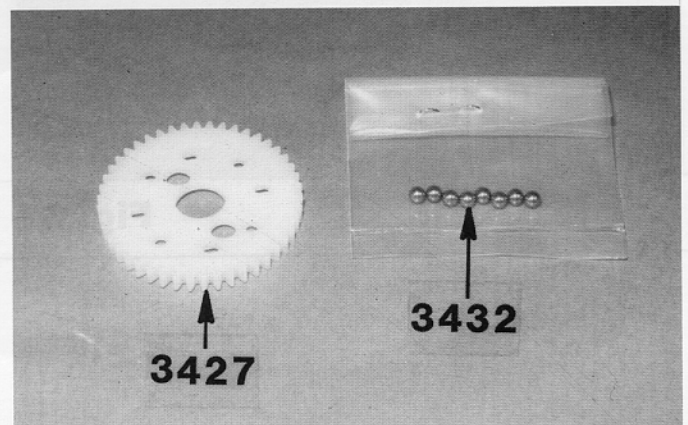
**Fig. 58**



**Fig. 59**

## DIFFERENTIAL

□ **Fig. 60**—Open Bag #8. Take the #3432 diff (differential) balls out of the plastic bag and pop them into the #3427 spur gear.



**Fig. 60**

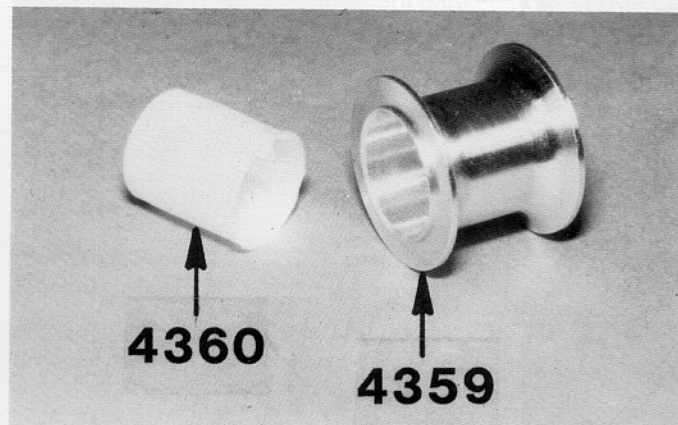


□ **Fig. 61**—Take the #6636 diff lube and place a small amount on each ball on each side of the gear. **VERY IMPORTANT**—do not use any other kind of diff lube or grease on the balls, because your diff will not work correctly if you do. Our #6636 diff lube is a very special compound designed for our particular diff.



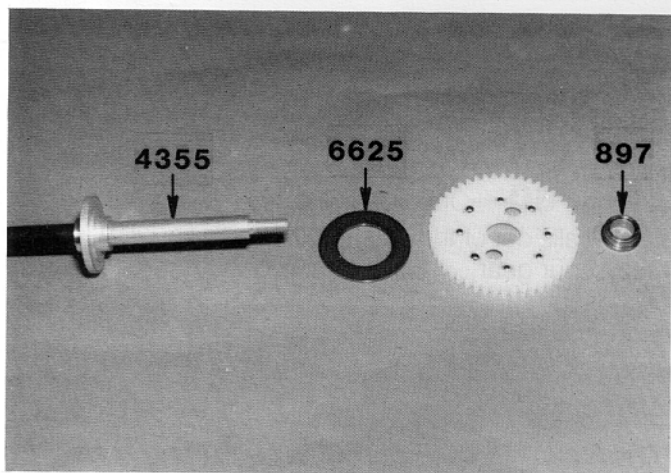
**Fig. 61**

□ **Fig. 63**—Slide the #4360 plastic ball bearing mount into the #4359 wheel spacer so that the thin end of the bearing mount goes in first.



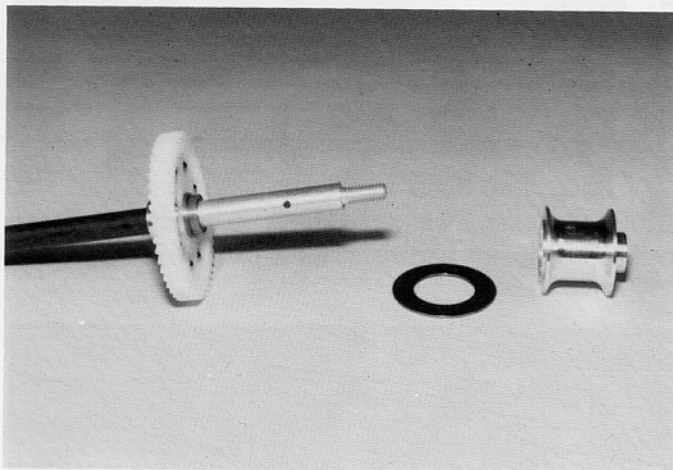
**Fig. 63**

□ **Fig. 62**—Slide and seat a #6625 drive ring onto the #4355 diff axle. It's easier to do if you hold the axle upright. Slip one of the #897 ball bearings onto the axle next, with the larger flanged end on first. This ball bearing must be able to slip into the #4360 ball bearing mount later.



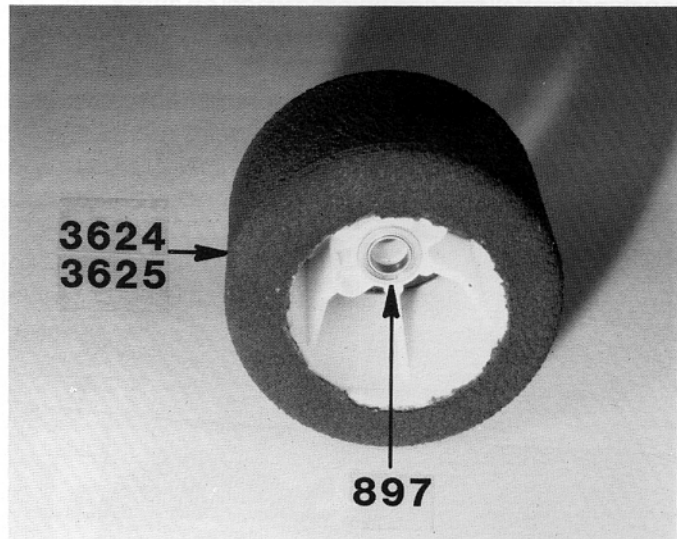
**Fig. 62**

□ **Fig. 64**—Slip another drive ring onto the axle and then slip the wheel spacer on. You'll have to center the drive ring so that the wheel spacer will seat correctly.

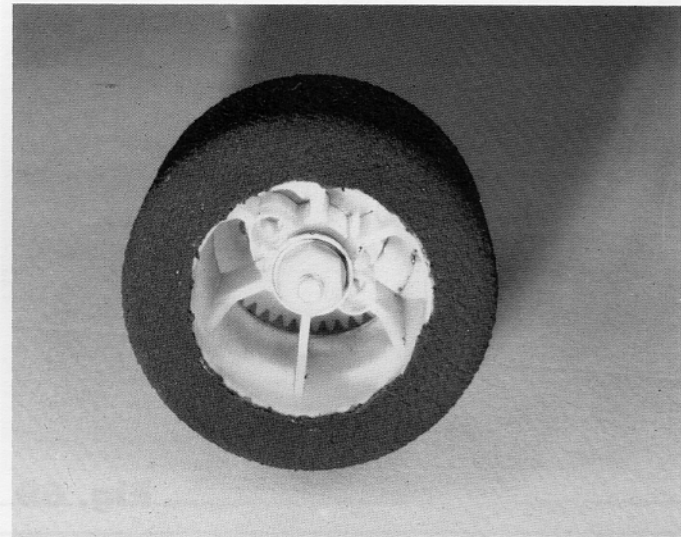


**Fig. 64**

□ **Fig. 65**—Push another #897 ball bearing into the RIGHT HAND ONLY rear wheel, as shown.

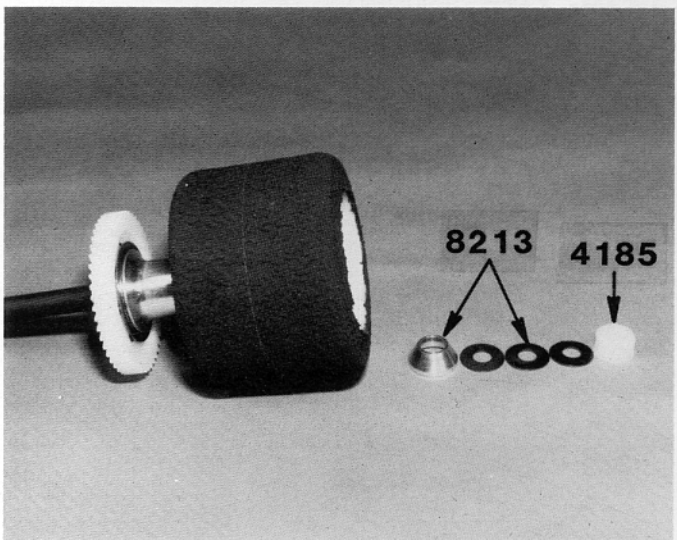


**Fig. 65**



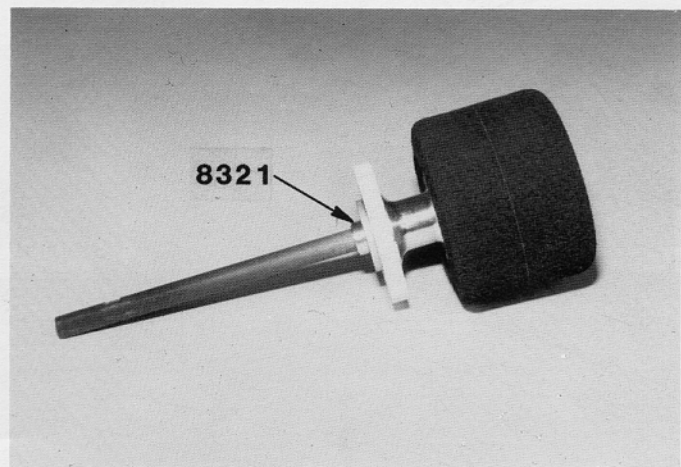
**Fig. 67**

□ **Figs. 66 & 67**—Slip the wheel on the axle. Now slip the tapered aluminum spacer on next, so that the smallest tapered end goes on first. Now slip the three tapered Belleville washers on next, so that the taper is pointing to the outside. Screw the nylon nut on and tighten by hand. Hold the axle in your left hand. Turn the wheel with your right hand. It should turn freely. If it doesn't, the drive rings are misaligned. We'll adjust the diff later.

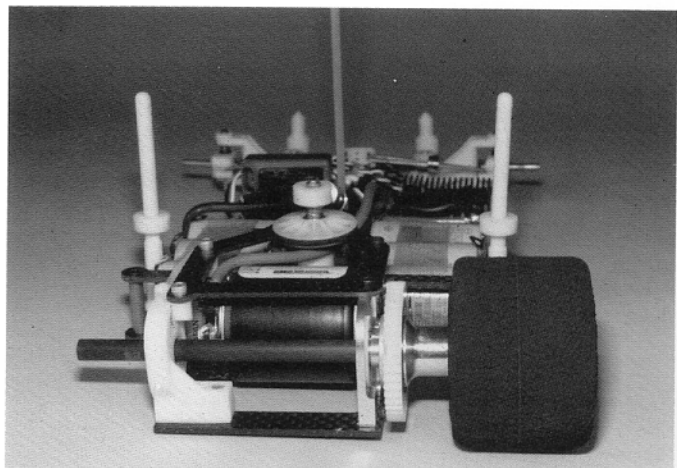


**Fig. 66**

□ **Figs. 68 & 69**—Slip a #8321 aluminum spacer onto the axle so that the stepped end of the spacer will be touching the #897 ball bearing in the rear pod. Slip the rear axle assembly into the rear pod, making sure the spur gear clears the pinion gear.

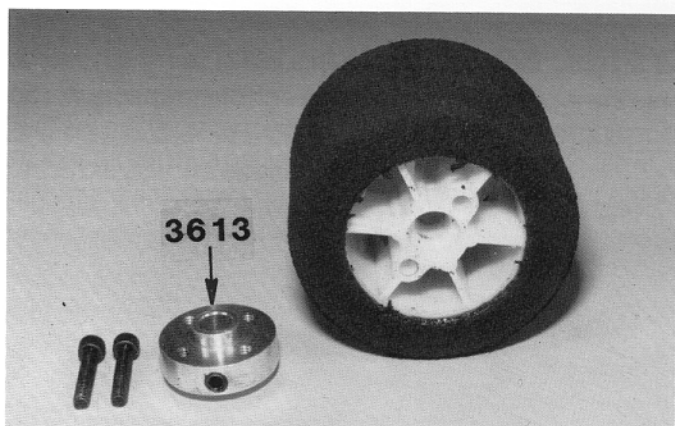


**Fig. 68**

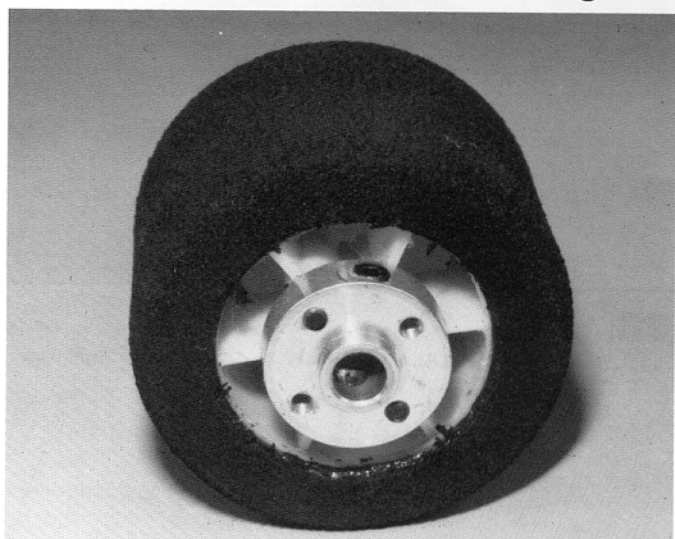


**Fig. 69**

□ **Figs. 70 & 71**—Install a set screw into the #3613 wheel hub and then install the wheel hub to the inside of the left hand wheel, as shown.



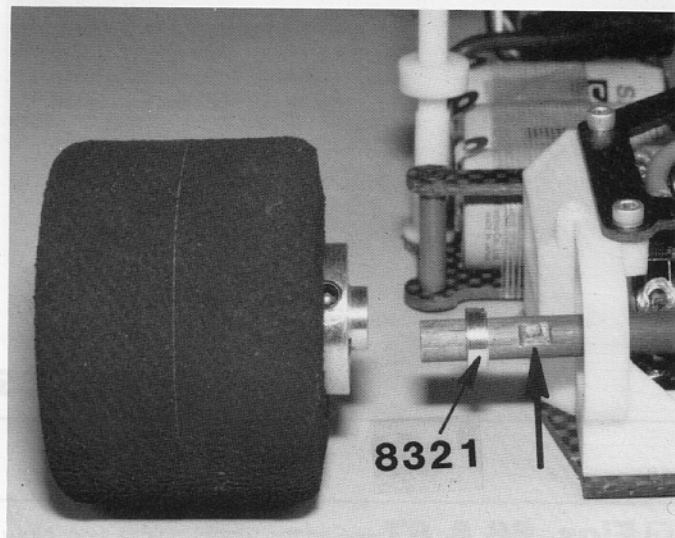
**Fig. 70**



**Fig. 71**

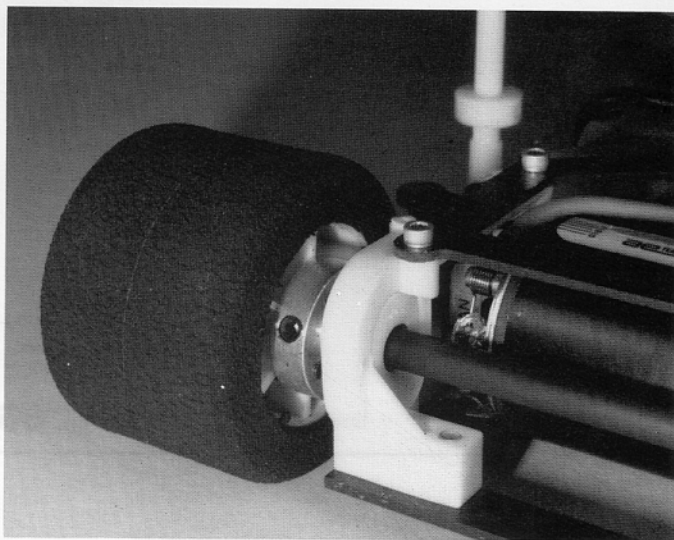
□ **Fig. 72**—Slide the other #8321 aluminum spacer onto the axle so that the stepped end of the spacer will be touching the ball bearing. Slip the wheel on and tighten the set screw just enough to mark the axle.

Remove the wheel, spacer, and then remove the axle assembly from the pod and file a small flat spot on the axle where the set screw touched, as shown in the photo. This will make removing the axle later a little easier.



**Fig. 72**

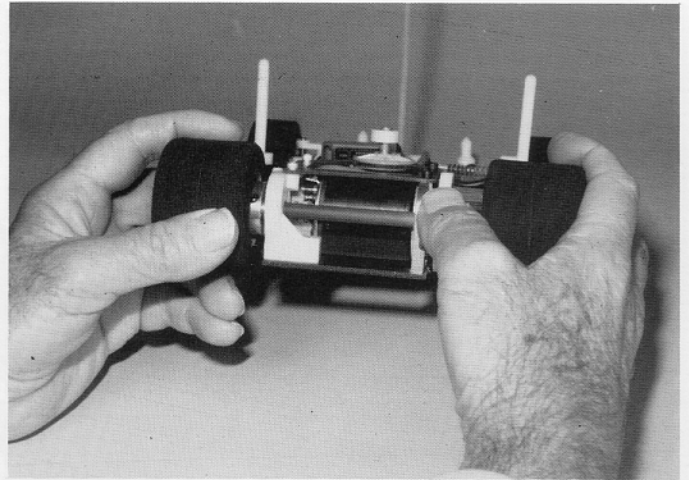
□ **Fig. 73**—Re-install the axle, spacer and then the left hand wheel. Tighten the set screw lightly. We need a very small amount of end play. See if the axle will slide a very small amount to the left and right. If it will, tighten the set screw down.



**Fig. 73**

□ **Fig. 74**—Now we'll adjust the diff. Hold the left hand wheel in your left hand and the right hand wheel in your right hand, as shown. Hold the wheels from turning. Take your right hand thumb, as shown, and push on the spur gear to see if you can turn it. If it will not turn, loosen the adjustment nut, shown in Fig. 67, until you can just barely push the gear forward. Now, tighten the nut just a very small amount. If you cannot push the gear forward now, then your diff is correctly adjusted.

Set the car flat on a table. Now refer back to Fig. 16 and very carefully screw down each tweak screw so it just touches the chassis and NO MORE.



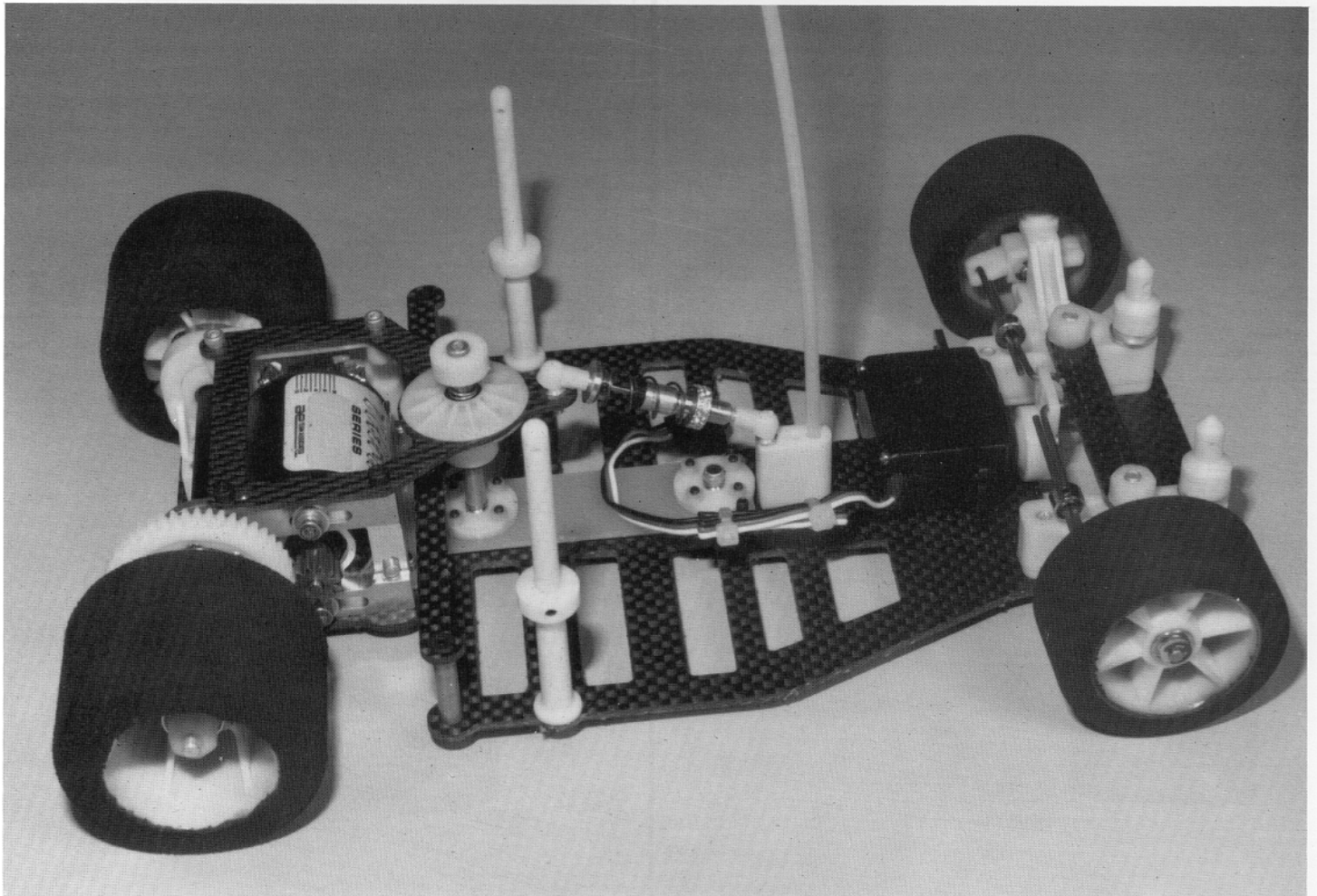
**Fig. 74**

## **ELECTRICAL**

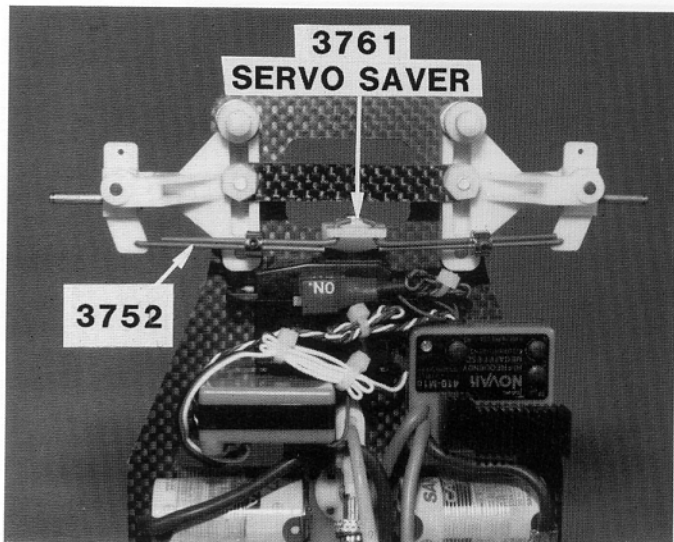
□ **Figs. 75 & 76**—We'll start with the steering servo. Line up the steering servo exactly as shown in Fig.

76 and attach it to the chassis with a piece of the black double stick servo tape.

Install the servo saver on the servo. Now install the #3752 tie rod linkage, as shown, with the set screws in the two locking collars aligning the front axles, as shown.



**Fig. 75**



**Fig. 76**

□ **Fig. 77**—This step applies only to the graphite chassis. Graphite conducts electricity somewhat like metal, so for electrical purposes, think of graphite as metal. Because of its conductivity we need to make sure our batteries are properly insulated so they won't short out to the chassis. This step will not apply to you if you have a fiberglass chassis because fiberglass is already an insulator.

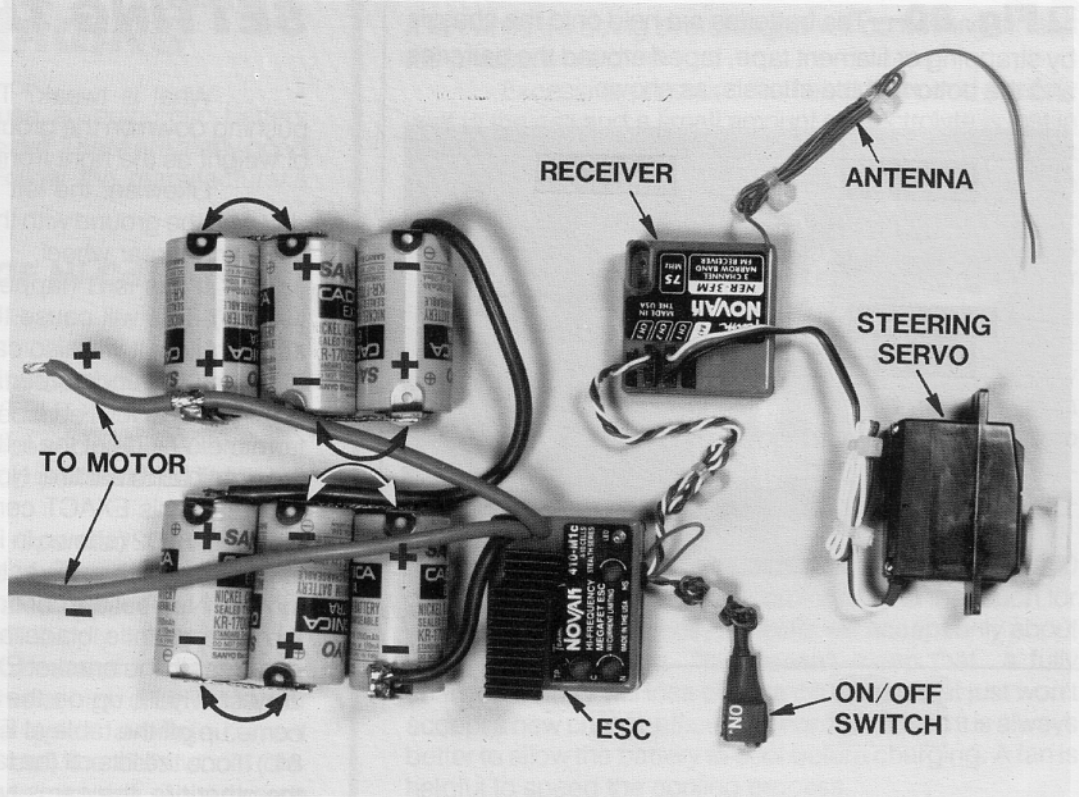
The shrink wrap on the battery cell is an insulator and we've filed the sharp edges off the chassis so it won't cut through it, but we still need to go one step further. We must add some black electrician's tape to the chassis where the pointer is showing in the photo. Add the tape to all eight ribs where the batteries touch. It's also VERY IMPORTANT to make sure none of our solder connections can touch the chassis anywhere.



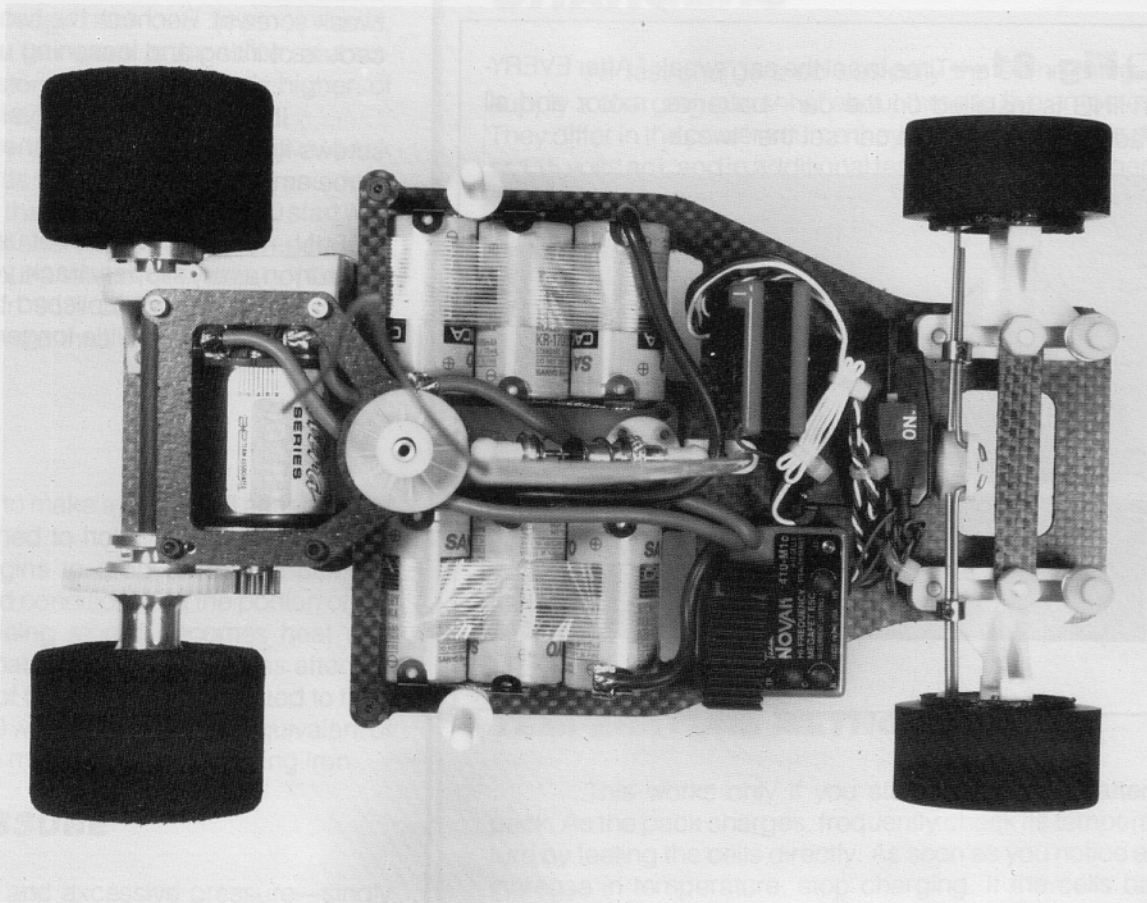
**Fig. 77**

□ **Figs. 78 & 79—**

This shows the wiring diagram for a Novak ESC (Electronic Speed Control) out of the car and installed in the car. Other speed controls will install differently, so always go by the ESC manufacturer's instructions.

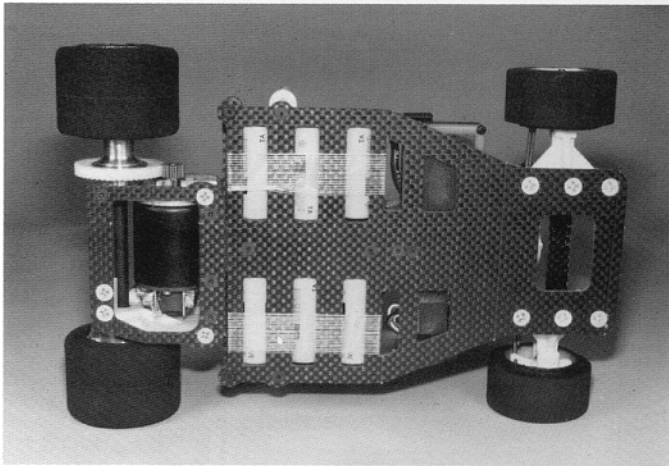


**Fig. 78**



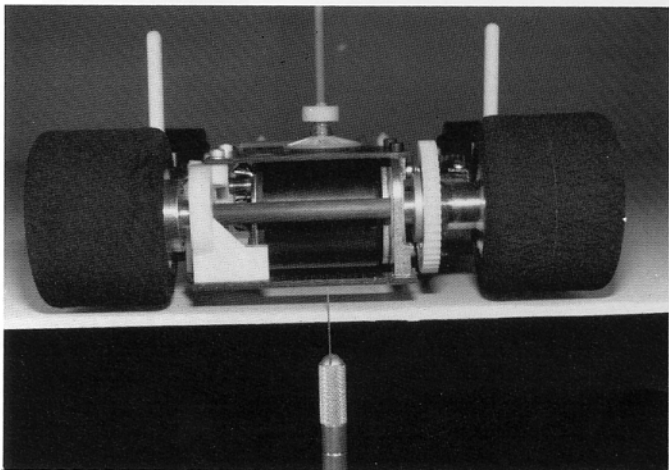
**Fig. 79**

□ **Fig. 80**—The batteries are held onto the chassis by strapping or filament tape, taped around the batteries and the bottom of the chassis, as shown.



**Fig. 80**

□ **Fig. 81**—Time to set the car "tweak." After EVERYTHING is installed on the car—batteries, motor and all radio equipment—we can set the "tweak."



**Fig. 81**

## SETTING THE TWEAK

What is tweak? The left front wheel should be pushing down on the ground with the exact same amount of weight as the right front wheel.

Likewise, the left rear wheel should be pushing down on the ground with the exact same amount of weight as the right rear wheel.

If this isn't happening, the car is TWEAKED (or twisted). This will cause the car to spin out easily under acceleration; it will also cause it to have oversteer in one direction and understeer in the other direction.

TO CHECK THE TWEAK, take a ruler and measure from the outside of the left hand rear tire to the outside of the right hand rear tire. Now take exactly half that amount and mark this EXACT centerline of the car on the lower bracket #8202 (shown in Fig. 81). Just scratch a mark on the bracket with an Exacto knife.

Now set the car on a very flat and level table. Take the Exacto knife blade and put the edge of the blade underneath the bracket EXACTLY where your mark is and very slowly lift up on the blade. BOTH rear tires should come up off the table at EXACTLY the same instant. (Fig. 81.) If one tire lifts off the table the slightest amount before the other tire, the car is tweaked.

TO CORRECT THE TWEAK, refer back to Fig. 16 and loosen one screw 1/8 of a turn (arrows point to the tweak screws). Recheck the tweak. Keep doing this procedure of lifting and loosening until the tweak is flat.

IMPORTANT— Always loosen one of the two screws first and then tighten the second screw the exact same amount.

TOE-IN—Normally, we do not use toe-in or toe-out. But if you run on a very slippery track, you might want to try some toe-in. Toe-in is accomplished by adjusting the tie rods (Fig. 76) so they're a little longer.

# BATTERY CHARGING

We recommend you use an automatic battery charger like Novak and others make. There are many good brands on the market now. Follow the manufacturer's guidelines.

## CHARACTERISTICS OF Ni-Cd BATTERIES

It is important to understand the characteristics of the battery pack in your car, because how you use it will greatly affect both its performance and its life. With proper care your pack will give you top performance for many hundreds of cycles.

The R.O.A.R.- (Radio Operated Auto Racing, Inc.) legal battery is composed of either four or six "sub-C" size cells with a maximum rated capacity of 1.2 amp-hrs. This means that the cells will supply 1.2 amperes for one hour, or 0.6 amperes for two hours, etc. This capacity rating drops to about 1.0 amp-hrs at high drain rates. For instance, at fifteen amperes (a typical average current drain for a 1/10 scale electric car) the cells would discharge in 1/12 of an hour (five minutes). This charge capacity is the same regardless of the number of cells in the pack because the cells are connected in series and the same current passes through each one. In other words, the charge capacity of a four-pack is the same as a six-pack. The total energy storage of a six-pack is higher, of course, because the voltage is higher.

Ni-Cds are very efficient and they give back almost as much charge as you put in, as long as you don't try to put in more charge than they will hold. If you start with a completely dead pack and charge at four amperes for 1/4 hour, you will have put a total of one amp-hr ( $4 \times 1/4$ ) into the cells. More than 95% of the charge would be recovered if the pack were then discharged at the one hour rate.

## OVERCHARGE

There is no way to make a Ni-Cd cell accept more charge than it is designed to hold. This means that the charging efficiency begins to drop off as the cell approaches a fully charged condition; and the portion of the charging current not being stored becomes heat and pressure. This means that if charging continues after the cell is fully charged, all of the current is converted to heat and pressure—about 40 watts worth—or the equivalent of the heat produced by a medium-sized soldering iron.

## HEAT AND PRESSURE

Excessive heat and excessive pressure—singly or combined—is harmful to the cells; and getting rid of one won't offset the other. For example, cooling the battery with

a fan while it's being overcharged will do nothing to stop the pressure build-up.

Excessive pressure momentarily opens a safety vent in the cell and a small amount of electrolyte is lost in the process. One such occurrence is not harmful, but frequent venting will permanently reduce the performance of the cell. Excessively high temperatures can permanently damage the separators. High temperature also has temporary bad effects that will be explained later, under the heading, "High Temperature".

Ni-Cd cells have a built-in process for recombining the accumulated gas (actually oxygen) produced by overcharging, but the process produces heat and takes a lot of time. If you overcharge your battery and it seems to take a long time to cool down, it's because this pressure-reducing reaction is taking place. Once the gas is recombined, the temperature drops.

A hot Ni-Cd pack cannot be fully charged. At 130 degrees F (a temperature uncomfortable to the touch for more than a few seconds) the cells will accept only about 50% of a full charge. This doesn't mean that a fully charged battery will lose charge if it's heated; it just won't accept a new charge efficiently. For this reason it is always better to allow the battery to cool before charging. A fan is helpful to speed the cooling process.

## CHARGERS

All fast-chargers do basically the same thing—supply a charging current of about three to five amperes. They differ in the power source they use (either 12 volts dc or 115 volts ac), and in additional features. Some chargers have features like a built-in voltmeter, constant-current, voltage peak detection, or temperature sensing. Naturally, the more features a charger has, the more expensive it becomes.

## HOW TO TELL WHEN YOUR CELLS ARE CHARGED

One of the problems with Ni-Cds is their inherent voltage stability; the voltage of a fully charged cell is not much different from one that's about dead. For that reason several indicators, along with some common sense, are needed in order to get the most out of your battery. The following is a list of indicators you should use to detect full charge.

## TEMPERATURE METHOD

This works only if you start with a cool battery pack. As the pack charges, frequently check its temperature by feeling the cells directly. As soon as you notice an increase in temperature, stop charging. If the cells become too hot to hold onto, your cells are excessively overcharged. Let them cool.



## **TIMED CHARGE METHOD**

This works only if you have confidence in the timing accuracy of your charger. Many chargers on the market only approximate a constant charging current; they may vary from six amps when you first start charging, all the way down to two amps if the Ni-Cd pack is nearly charged and the voltage of the charging source (automobile battery) is low. If the charging current varies, it becomes difficult to estimate the average current. However, if your charger is reasonably dependable, you can use the following method.

Cycle your pack several times using the "temperature method" above. After you run the car the last time, let the pack cool. Charge again using the temperature method, but this time keep track of the time required to reach full charge. Once you have established the time, you can use it as a setting for the timer on your charger. To be safe, use a setting about a minute less than what you established. This method allows you to charge without constantly monitoring the battery temperature.

If you charge a battery that is still hot from running, reduce the time about 20%. Then, after the pack has cooled, finish charging with the temperature method.

## **VOLTAGE METHOD**

As mentioned earlier, voltage is a poor indication of a cell's state of charge. The change in voltage from 10% charged to 100% charged is usually less than 0.1 volts per cell. In fact, other factors like temperature, current drain, and "cell memory" have a greater effect on voltage than the state of charge does. However, if current flow and temperature are held constant, it is possible to see the cell voltage gradually climb during the charging process. The absolute value of this voltage isn't of much use—how the voltage changes is an excellent indicator. To use this method, you will need a digital voltmeter or an expanded-scale voltmeter capable of resolving 0.01 volts on the 10 volt range.

Connect the voltmeter across the Ni-Cd pack, preferably right at the cell terminals, or, if that's not possible, across the terminals of the throttle control resistor. Don't try to read the voltage at the output of the charger because you'll end up reading the voltage drop through all the connectors and cables between the charger and the Ni-Cd pack, which can sometimes distort the effect you're looking for. You should start with a Ni-Cd pack that is less than half charged. Connect your charger and begin charging at four amps. If your charger is adjustable, set the current now—don't try to change it later. A constant current charger is preferable here, but if yours gradually drops off during charge, that's still permissible, as long as it doesn't drop below three amps.

Watch the voltage as the pack charges. Notice that the voltage at first climbs rapidly and in the middle of the charging cycle more slowly. This voltage will most

likely be in the range of 8 1/2 to 9 volts for a six cell pack. As the pack approaches full charge, the voltage will begin to climb more rapidly; and as it goes into overcharge, the climb will slow down and then stop. This is where you stop charging—at the point where the voltage stops climbing. If you left the charger on, the voltage would begin to fall as the pack went deeply into overcharge and started to heat up. The maximum voltage reached will probably be in the nine to ten volt region; the actual value is unimportant.

Don't try to use a conventional voltmeter. Even a good quality VOM with a large, taunt-band, mirrored-scale meter movement isn't adequate; by the time you could see that the voltage had stopped rising, it would be too late.

## **SLOW CHARGE METHOD**

Slow or "overnight" charging is a method you are not likely to use often. However, it is a good way to bring the pack to absolutely full charge.

The charging current must be between 0.05 and 0.12 amperes. If less current, the pack will never reach full charge; any more and the pack will overheat. The time required to reach full charge ranges from 15 to 40 hours, depending on the current used. The charger can be left on for a much longer time without harming the cells, however, the output voltage of the pack will be temporarily lowered by an extremely long overcharge. The voltage returns to normal after a discharge-charge cycle.

## **GETTING MAXIMUM VOLTAGE TO THE MOTOR**

The tips that follow are really for the benefit of serious racers, since these tips deal with factors that influence the voltage and available power of a Ni-Cd pack. We're talking about a difference of maybe 15% at the most, so if you're just out having fun, don't worry about it. Instead, skip ahead to the Radio section.

The output of a fully charged pack can vary considerably, depending on the temperature and recent activity of the pack. These effects are listed below.

**HIGH TEMPERATURE** contributes its bad effects by lowering the output voltage under load. Less voltage means less speed. At normal 130 degrees F, the voltage of a six cell pack can be almost a volt less than normal. Since a lot of heat is produced in the pack while the car is running, it's important to allow air to circulate around the batteries to keep them cool. Therefore, before the start of a race, keep your car out of the sun and off the hot asphalt.

**MEMORY** can also affect the output voltage. The first memory effect is caused by overcharging. The cells "remember" that they were overcharged and put out less voltage near the end of the discharge cycle. This is particularly noticeable if the pack is slow-charged for too

long a time.

The second memory effect is caused by repeatedly not using up all of the battery's stored charge before recharging. The cells "remember" that they weren't fully used and let the voltage drop off to about one volt at the point where discharge usually stops. An example would be where you run a series of five minute heats, recharging between each heat, and then try to run an eight minute heat. The battery voltage will be low for the last three minutes of the race. The cure is to fully discharge the pack before recharging. "Full discharge" means the point where the first cell goes dead. Never discharge beyond that point.

The third memory effect is the "topping-up" effect of recent charging. The cells remember that they were recently charged and will produce a little more voltage early in the discharge cycle. Racers take advantage of this by putting the last minute or two of charge into their pack just before the race starts.

## **GETTING MAXIMUM PERFORMANCE**

**FULL DISCHARGE.** Ni-Cd packs perform best if they are completely discharged before they are charged. If you are involved in racing, you will have to do this if you expect to win any races! Various clip-on discharge resistors (about 30 ohms, 10 watts) are available at hobby stores. Discharge for at least an hour (preferably overnight with a clip-on resistor) before charging.

**TOPPING-UP** can give you a little extra voltage at the beginning of a race, as long as you don't overdo it. Put the last minute or two of charge into your pack just before the race starts.

## **YOUR RADIO**

Now that you know all about batteries, go ahead and charge your batteries. After the car batteries are charged and the transmitter batteries are charged, we'll set the steering servo and speed control.

Now turn the transmitter on. Hold the rear tires off the ground and turn the receiver switch on. The motor may start to run, which means your speed control must be set. Whether the motor runs or not, **THE SPEED CONTROL MUST BE SET NOW.** Set it according to the manufacturer's recommendations. This is a very critical adjustment and will determine the car's top speed and battery life. Set it so there are no brakes. The car will have enough steering, so brakes are not used.

After the speed control is set, turn the receiver switch off.

Remove the steering servo saver from the servo. Turn the transmitter on and then the receiver switch on.

Push the Kimbrough servo saver back on and align it so that the wheels are pointing perfectly straight forward. Install the servo saver screw.

Turn the steering wheel to the right. With your car pointing away from you, the wheels should turn (steer) to the right. If they turn to the left, move the steering servo reversing switch on the transmitter.

## **YOUR MOTOR**

Associated recommends the Reedy Modified motors. These motors have won seven IFMAR World Championships. No other motors have come close to this record. Check your RC12LW catalog for the various types of motors.

If you treat it properly, your motor will not only last much longer, but will run faster for a longer time too. So never let the brushes wear down too low. If they show signs of wearing, install new brushes. And never deliberately stall your motor. If your car is stuck in the wall, don't punch the throttle; you'll end up burning out your motor and speed control.

Reedy also makes a motor cleaner and motor lubricant—two excellent products vital for the care of your motor.

## **TRANSMITTER DUAL RATE**

You should always turn the front wheels the **LEAST AMOUNT NECESSARY** to get around the track fast, not the most amount. So use the dual rate switch on your transmitter to give you the exact amount of steering you need and **NO MORE.**

## **YOUR BODY**

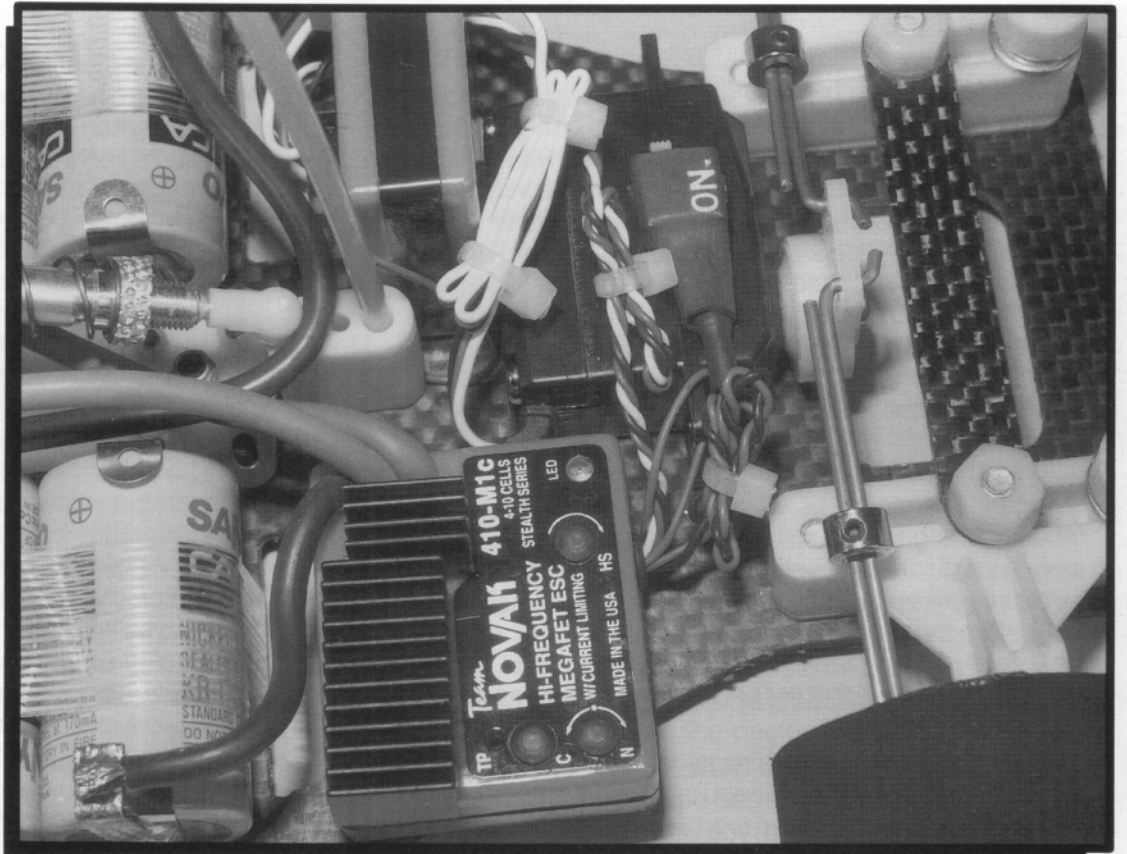
**MOUNT** your body on the car while it is still clear so you can see through it to easily mark the body mount holes and antenna holes. The bottom of the body should be even with the chassis.

**PAINT** your body by masking off the inside of your body with regular automotive masking tape according to your paint scheme. Follow the tips that come with your Associated body you purchase separately. The best body paint to use is Pactra, available in all hobby stores.

## **YOUR WING**

You probably won't need a wing if you run on carpet, but if you run on asphalt, try the car with and without a wing to see which works best on your track.

# REZWA



ASSOCIATED ELECTRICS, INC.  
3585 CADILLAC AVENUE  
COSTA MESA, CA 92626

**TEAM ASSOCIATED** 

