

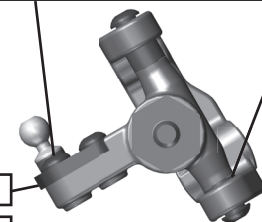

Front Suspension:

Ride Height: 28 mm
Camber: -1°
Toe: +1 (Tierod Gap = 41.8 mm)
Arm Type: #71103 Flat, Standard
Tower Type: #71115 Flat
Caster Block Insert: 5°
Steering Block: 4 mm
Bulkhead Type: #91656 Plastic
Kick-Up Angle: 25°
Wheel Hex: #71111 8.5 mm Steel
Notes: #1366 FT Aluminum Servo Horn, 25T
 #91667 Plastic Steering Rack
 #91668 Aluminum Steering Bellcranks

Anti Roll Bar:
 White (1.2mm)
 Gray (1.3mm)
 Blue (1.4mm)
 Other:

Bump Steer Spacing: 1 mm

Axle Height:
 +3
 +2
 +1
 0

Ball Stud Spacing: 1 mm

Steering Plate: #91679 Kit
Steering Stop Spacing: 0

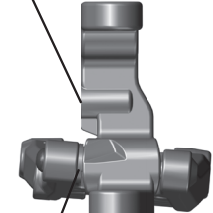

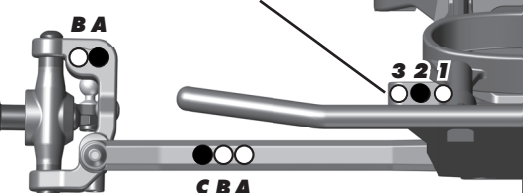
Caster Block Spacing: 1 mm

Ball Stud Spacing: 1 mm

Rear Suspension:

Ride Height: 27 mm
Camber: -1.5°
Arm Type: #71105 Standard
Tower Type: #71116 Standard
Wheel Hex: #91610 FT 7.0 mm
Hub Spacing:
 Forward Middle Back
Shock Mounting Position:
 Front of Arm Rear of Arm
Notes:

Anti Roll Bar:
 White (1.1mm)
 Gray (1.2mm)
 Blue (1.3mm)
 Other:

Rear Hub Link Setting:
 Plastic Hub Aluminum Hub Ball Stud Spacing: _____

C Mount Inserts: 1° 0.5°
 Aluminum Brass

D Mount Inserts: 1° 0.5°
 Aluminum Brass

Hub Insert:
 +3 +2 +1 0

Ball Stud Spacing: 0 mm

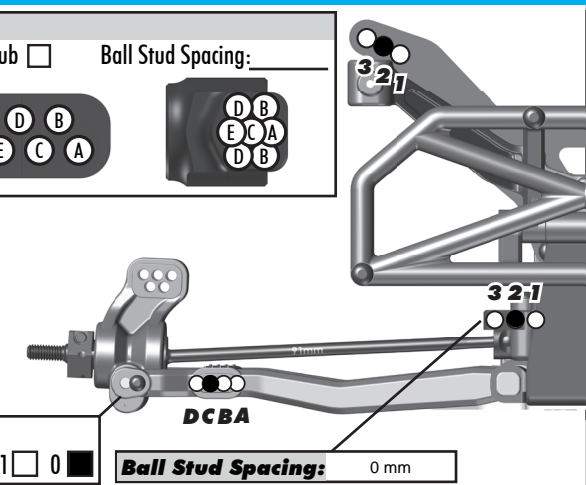

Electronics:

Radio: Sanwa M12S **Servo:** #27101 Reedy RT1508
EPA: Throttle: 100 % Brake: 95 %
ESC: #27004 Reedy Blackbox 510R
ESC Settings: N/A
Motor: Reedy S+
Wind: 13.5 **Timing:** 31°
Pinion: 22 **Spur:** 84
Battery: #27323 Reedy Zappers SG 5800 mAh 80C
Battery Position: 3F

Drivetrains:

Transmission: **Laydown:**
3 Gear: **Layback:**
4 Gear: **Stand Up:**
Differential: **Ball Diff:**
Height: 0 **Gear Diff:**
Notes: Diff Set Tight

Slipper Clutches:

Type: Team Associated Kit
of Pads: 2 x #91197 LCF

Shocks:

	Front	Rear
Piston:	2 x 1.6 Machined	2 x 1.7 Machined
Fluid:	35 wt	30 wt
Spring:	#91637 Truck Gray	#91639 Truck Green
Limiters:	2	1
Stroke:	27.5 mm	35 mm
Eyelet Length:	Long	Short
Cup Offset:	5 mm	5 mm
Notes:	#91494 Machined Shock Spacers	

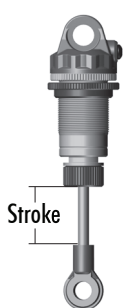

Track Info:

Size: Small Medium Large Extra Large
Surface: Dirt Carpet Astroturf Multi Surface
Traction: Low Medium High Very High
Moisture: Dry Damp Wet
Condition: Indoor Outdoor Dusty Hard Packed
 Bumpy Grooved Smooth Loamy
Temperature: Ambient: 70 F Track: 70 F
Notes:

Tires:

Front Tires: JConcepts Dirt Webs
Front Compound: Gold
Front Insert: JConcepts Dirt Tech
Rear Tires: JConcepts Dirt Webs
Rear Compound: Gold
Rear Insert: JConcepts Dirt Tech
Wheel (F/R): JConcepts Hazard +3
Notes:

Body, Wing, Weight:

Body: JConcepts Hi-Flow
Body Height: Kit
Servo Weights:
 None Aluminum Steel Other
Electronic Weights: #91754 FT Graphite ESC Tray
 None Aluminum Steel Other
Total Vehicle Weight:

Vehicle Comments:

Notes: #91577 & #91579 Fox Shock Bodies; #91620 & 91624 Chrome Shock Shafts; #91744 FT Brass Under Battery Weight (43g)