

All-new three shock-design.

Two VCS Micro shocks handle side-to-side dampening and tweak, eliminating tweak screws. The larger center VCS Macro Shock provides the smoothest possible, most consistent dampening.

Super-strong, all-carbon **graphite chassis**

Wider **battery placement slots**

Race-proven **front suspension** with fully-adjustable caster, camber and toe-in, and inline steering blocks with threaded front axles

The aluminum **rear hubs** are unsurpassed for the tightest manufacturing tolerances and concentricity. Redesigned and milled out for substantial weight savings, there's no need to buy expensive aftermarket hubs anymore!

The **rear pod** allows two different offset positions.

"**Factory Team**" rear axle's graphite-through construction makes it the most concentric, and strongest rear axle design on the market today.

Featherweight, energy-absorbing **foam bumper** protects the front end and body from high-impact crashes

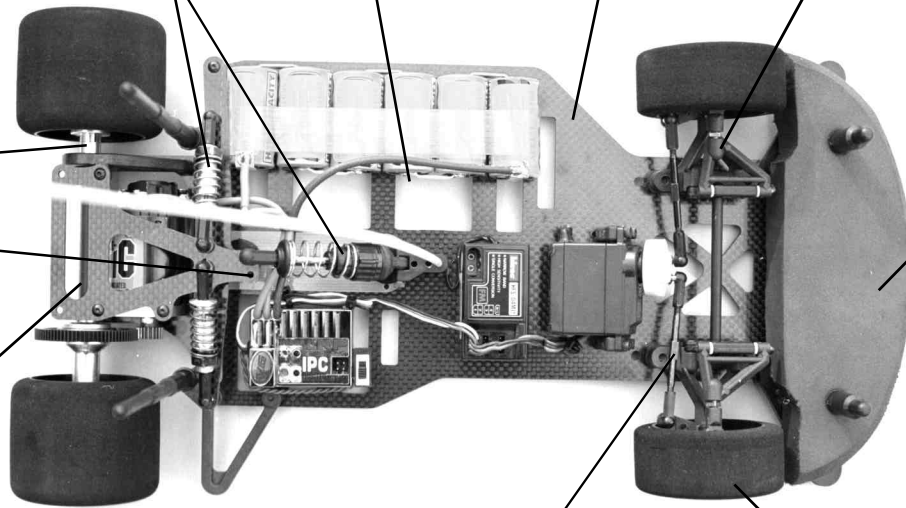

"**Factory Team**" blue titanium turnbuckles are standard equipment for their light weight and outstanding strength

Specially-selected compound **Jaco tires** mounted on their lightweight composite wheels at no extra cost, front and rear, through exclusive agreement with Pro-Line Racing

TOOLS

KIT TOOLS SUPPLIED

- 1 Allen wrenches, .050", 1/16", 3/32"
- 2 shock tools
- 3 metal turnbuckle wrench

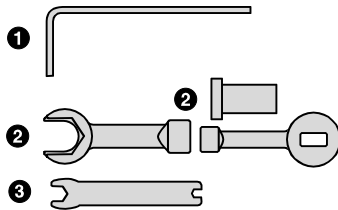

EXTRA TOOLS NEEDED

- 1 Phillips screwdrivers #2
- 2 needlenose pliers
- 3 soldering iron (40-50 watts) and a small amount of Rosin core solder. Pencil-type soldering iron is better than the gun type. **DANGER! Tip is HOT!**
- 4 Thread locking compound (#242 Blue Loctite® or equivalent)
- 5 hobby knife **WARNING! This knife cuts plastic and fingers with equal ease, so be careful.**
- 6 precision ruler
- 7 file
- 8 hand drill with 3/32" (or #43) drill bit
- 9 electrician's tape
- 10 strapping tape

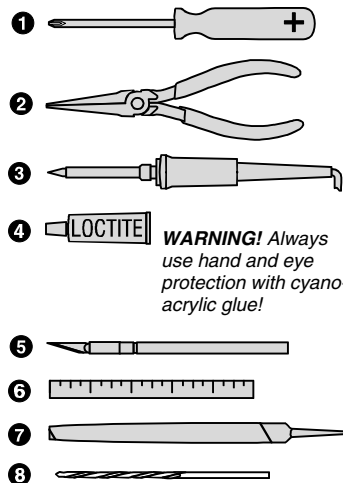

LOCTITE **WARNING!** Always use hand and eye protection with cyano-acrylic glue!

HELPFUL TOOLS (NOT REQUIRED)

- 1 Allen drivers (straight Allen wrenches with hex shaped handles) such as the following made by Associated:
 - #6957 .050" Allen wrench
 - #6958 1/16" Allen wrench
 - #6960 3/32" Allen wrench
 - 2 #6961 2.5mm Allen wrench
 - 3 Vernier calipers
 - 4 Hobby scissors
- Nut drivers (screwdriver-handled hex socket tools) such as the following from Associated:
- #SP-86 3/16" nut driver
 - #SP-85 1/4" nut driver
 - #SP-82 11/32" nut driver

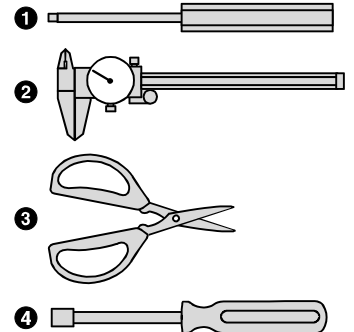

WARNING! Do not use a power screwdriver to install screws into nylon, plastic, or composite materials. The fast rotation speed can heat up the screws being installed. They can then

break or strip the threads during installation.

ITEMS NEEDED TO OPERATE YOUR CAR

- 1 R/C two channel surface frequency radio system.
- 2 *Battery pack (6 cell).
- 3 Battery charger (we recommend a peak detection charger).
- 4 *Electronic speed control.
- 5 *R/C electric motor.
- 6 *Pinion gear, size to be determined by type and wind of motor you will be using.
- 7 *1:10 scale Lexan body and wing.

* Available from Associated. See your 10L catalog.

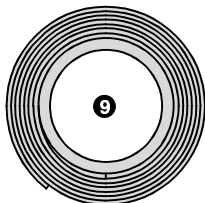
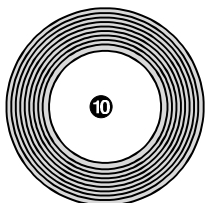

REACHING US

CUSTOMER SUPPORT

(714) 850-9342
 FAX (714) 850-1744
 web site: <http://www.rc10.com>
 ©1998 Associated Electrics, Inc.



ASSOCIATED ELECTRICS, INC.
 3585 Cadillac Ave.
 Costa Mesa, CA 92626
 USA

BEFORE BUILDING

OPEN THE BAGS IN ORDER

The assembly is arranged so that you will open and finish that bag before you go on to the next bag. **Sometimes you will have parts remaining at the end of a bag. These will become part of the next bag.** Some bags may have a large amount of small parts. To make it easier to find the parts, we recommend using a partitioned paper plate for spreading out the parts so they will be easier to find.

MANUAL FORMAT

The following explains the format of these instructions.

The beginning of each section indicates:

- 1 Which bag to open ("BAG A").
- 2 Which parts you will use for those steps. Remove only the parts shown. "1:1" indicates an actual size drawing; place your part on top and compare it so it does not get confused with a similar part.
- 3 Which tools you should have handy for that section.
- 4 In some drawings, the word "REAR" with an arrow indicates which direction is the rear of the car to help keep you oriented.

5 The instructions in each step are ordered in the order you complete them, so read the words AND follow the pictures. The numbers in circles are also in the drawing to help you locate them faster.

6 When we refer to left and right sides of the car, we are referring to the driver's point of view inside the car.

SUPPLEMENTAL SHEETS

We are constantly developing new parts to improve our kits. These changes, if any, will be noted in supplementary sheets located in a parts bag or inside the kit box. Check the kit box before you start and each bag as it is opened. When a supplement is found, attach it to the appropriate section of the manual.

Now clear off your workbench, line up some paper plates, grab your 50-cent soda, 39-cent cheeseburger, \$12.99 music CD, and let's begin!

BAG A

REMOVE THESE PARTS FOR:

8018: step 1

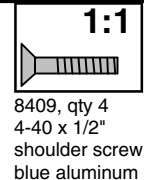
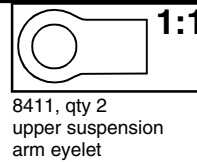
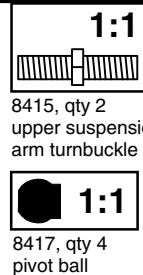
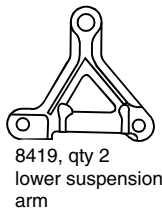
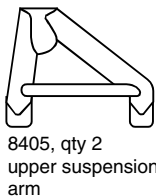

TOOLS USED

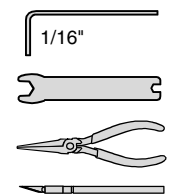

Step 1 LEFT SIDE

ASSEMBLE UPPER SUSPENSION ARM

- 1 Assemble parts #8405, 8415, and 8411.

ATTACH UPPER ARM MOUNT TO LOWER ARM

- 2 Attach #8407 0° mount to the #8419 lower suspension arm using two #8409 screws. **WARNING!** Screws are difficult to screw in. Turn carefully so you do not strip out the head.

INSTALLING UPPER AND LOWER PIVOT BALLS

- 3 Before popping in the pivot balls, make sure there are no burrs inside the pivot ball holes.
- 4 Pop the #8417 pivot balls into the suspension arms as shown. Make sure that the shoulders of the pivot balls in the lower suspension arms are facing upward and the pivot balls in the upper arm are facing downward as shown. Orient ball to the rounded side of the upper arm as shown.

5 Now assemble the right side.

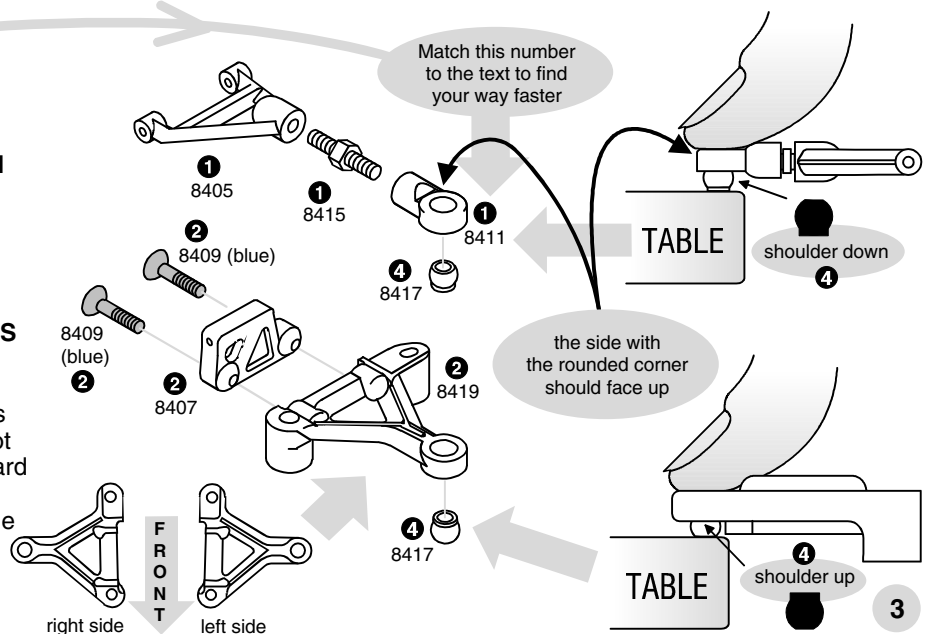

BAG A

REMOVE THESE PARTS FOR:

8018: steps 2-3

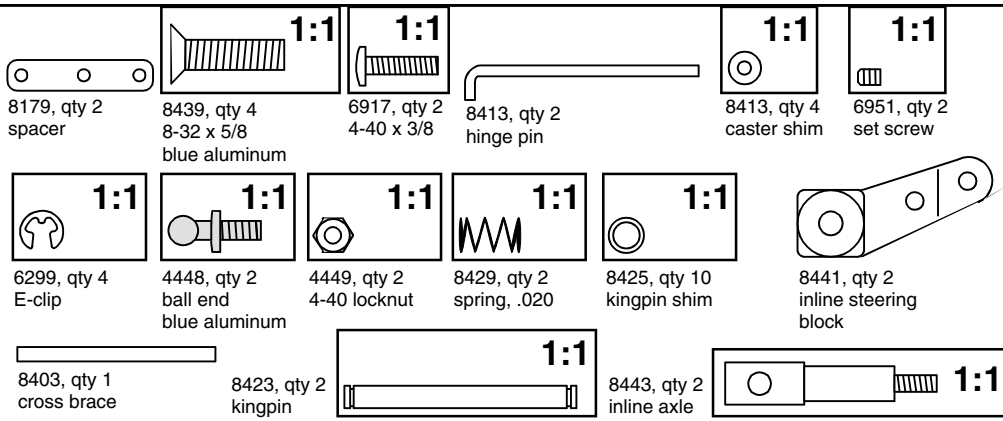

TOOLS USED

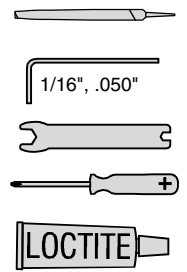

step 2

FILE THE CHASSIS

- Use your file to bevel the slots on the top of the chassis so the edges won't cut through the battery cell wrap. **WARNING! Graphite dust can be harmful to your health. File in a well ventilated area. Then wash the chassis with running water and dry with paper towels. Wash your hands afterward with cold water and soap. Deposit graphite filings in trash.**

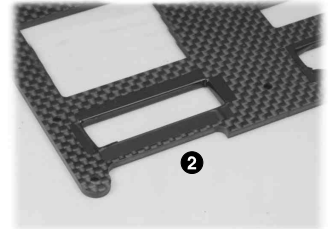
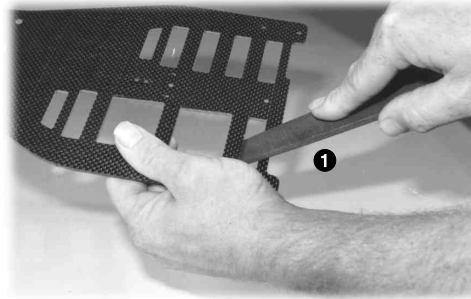

TAPE THE CHASSIS

- Insulate the battery slots by wrapping the slots with electrical tape.

NOTE: The bottom of the chassis has the screw holes countersunk.

step 3 LEFT SIDE

SUSPENSION ARMS TO CHASSIS

- Slip the #8179 spacer between the suspension arm and the chassis, using the sets of holes farthest forward, then bolt on with two #8439 blue aluminum screws from underneath the chassis. Do the other side.

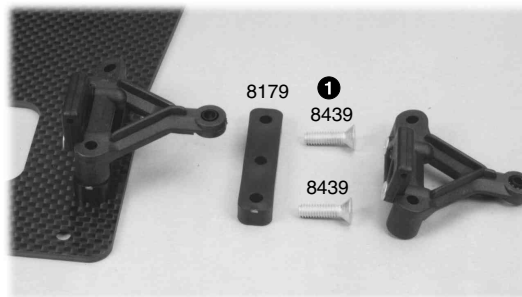

MOUNT THE CROSS BRACE

- Mount the cross brace to the front suspension using two #6917 button head screws.

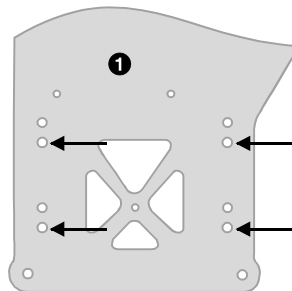

UPPER ARM TO THE SUSPENSION MOUNT

- Assemble the upper arm assembly to the suspension mount as shown, using the #8413 hinge pin and shims.

FINAL FRONT SUSPENSION ASSEMBLY

- Assemble the #8441 steering block as shown using parts #8443, 6951, 4448, and 4449. Install the ball end into the rear hole.
- Place one #6299 E-clip on the bottom of the #8423 kingpin then slide the #8429 spring over.
- Slide the #8423 kingpin completely through the bottom of the suspension arm and up through the steering block.
- Place one #8425 shim on top of the #8441 steering block.
- Now push the upper arm over the kingpin. Place four #8425 shims over the kingpin and secure with a #6299 E-clip.

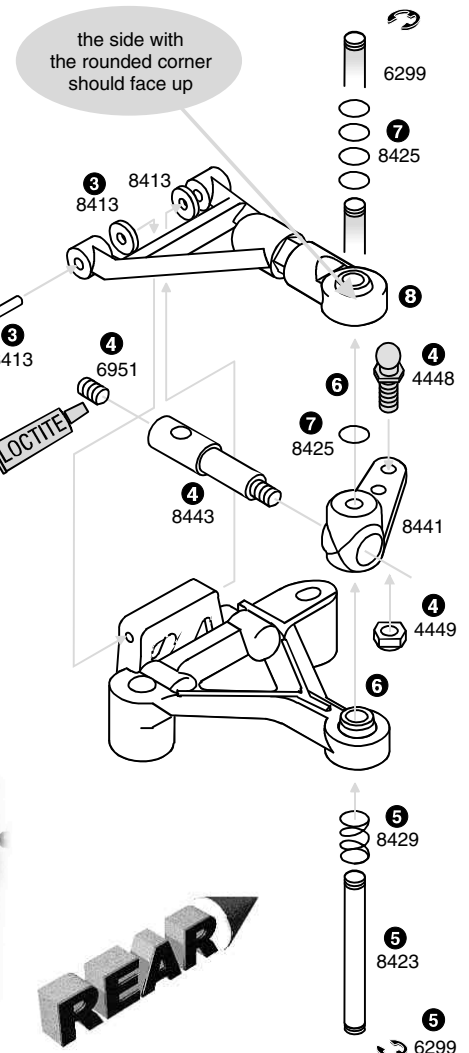
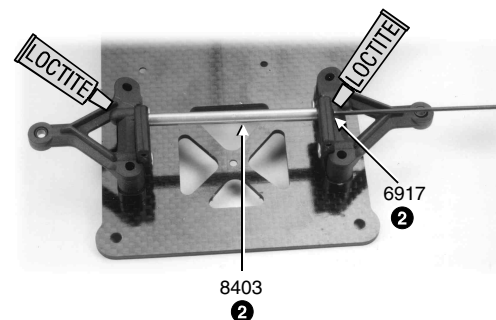

BAG B

REMOVE THESE PARTS FOR:

8018: steps 1-3



4335, qty 2 ea
pivot socket,
upper and lower



4334, qty 8
2-56 x 5/16

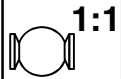

4336, qty 2
pivot ball



6292, qty 2
4-40 x 3/8
steel

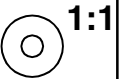

4526, qty 2
T-bar spacer
molded plastic



7260, qty 1
4-40 nut



6934, qty 3
4-40 x 3/8
blue aluminum steel

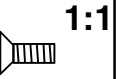

7673, qty 2
4-40 x 5/16
blue aluminum steel

TOOLS USED

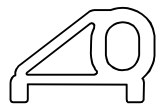
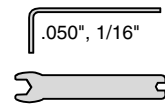

4536, qty 1
left rear bulkhead

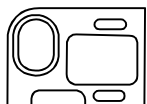

4537, qty 1
motor bulkhead

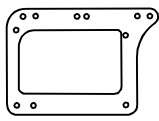

8461, qty 1
lower pod plate

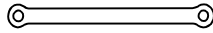

8192, qty 1
T-bar brace

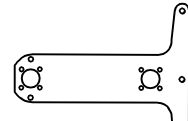

8191, qty 1
T-bar, .075"

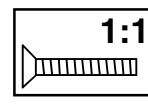

4519, qty 1
4-40 x 9/16

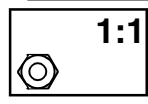

4449, qty 2
4-40 locknut

step 1 LEFT SIDE

T-BAR ASSEMBLY

- Assemble the #4335 T-bar sockets and #4336 pivot balls.
- Secure the T-bar pivot assembly to the #8191 T-bar using four #4334 screws as shown, installing both on the same side of the T-bar. The side with the screw head showing will be the bottom.

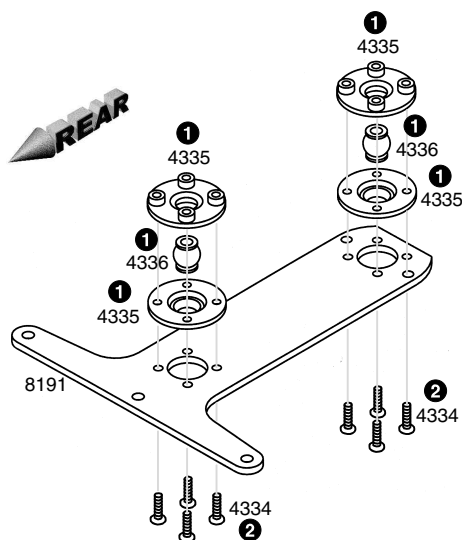

step 2 RIGHT SIDE

REAR POD ASSEMBLY

- Bolt the #8461 lower pod plate to the black #4536 left bulkhead with three #6934 blue aluminum screws.
- Bolt the aluminum #4537 motor bulkhead with two #7673 screws.
- Attach the lower pod plate to the T-bar with two #4526 spacers, two #6292 screws, and two #4449 locknuts. The spacer goes between the T-bar and the pod plate. The T-bar is on top. **Be sure to use the set of mounting holes shown in the drawing.**

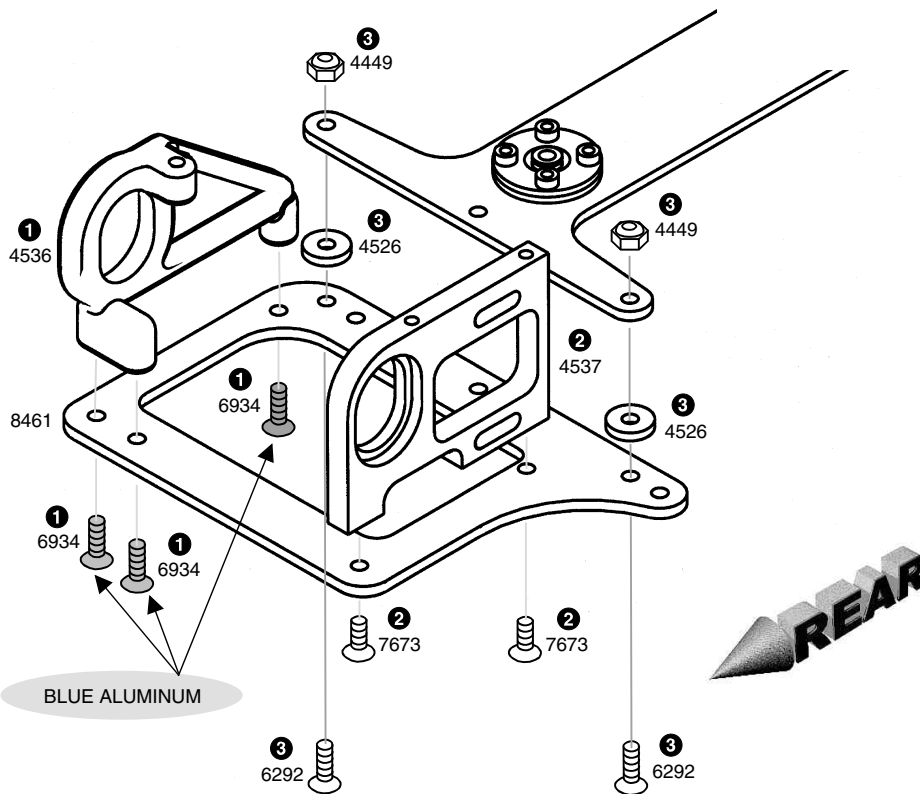

step 3 LEFT SIDE

T-BAR TO CHASSIS

- Insert the #4519 screw through the chassis hole shown and into the T-bar.
- Place the #8192 T-bar brace over the screw and secure with a #7260 plain nut.

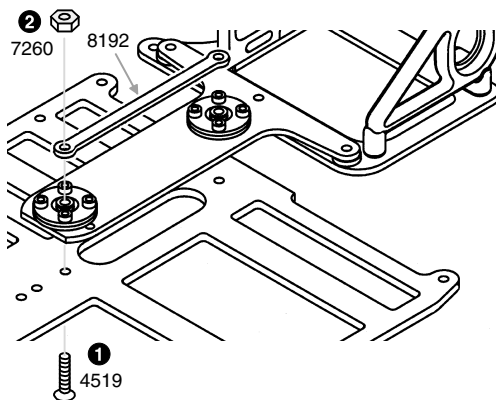

BAG B

REMOVE THESE PARTS FOR:

8018: steps 4-6

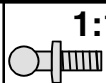

4448, qty 4
4-40 ball end
blue aluminum



6919, qty 4
4-40 x 5/16

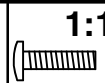

6917, qty 3
4-40 x 3/8



4449, qty 4
4-40 locknut



4442, qty 2
dampener brace
standoff



4515, qty 1
dampener center post

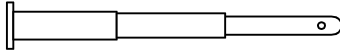

8186, qty 2
rear body mount

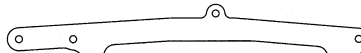

8462, qty 2
rear chassis brace

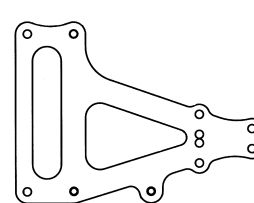

8463, qty 1
dampener plate

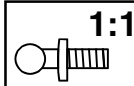

6270, qty 1
4-40 ball end
steel



6915, qty 1
4-40 x 5/8



6292, qty 1
4-40 x 3/8

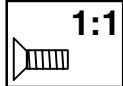

7673, qty 2
4-40 x 5/16



6372, qty 2
spacer

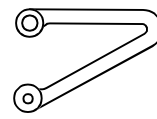

8312, qty 1
molded nerf bar

TOOLS USED

1/16"

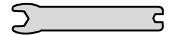

step 4 LEFT SIDE

REAR CHASSIS BRACE ASSEMBLY

- Mount the aluminum #4442 and #4515 standoffs to the #8313 rear chassis brace with one #6270 steel ball end and two #6919 screws where shown.
- Mount the #8186 rear body mounts to the rear chassis brace in the holes shown and secure the mounts using two #6917 screws.
- Mount a #4448 blue aluminum ball end with #4449 locknut where shown.

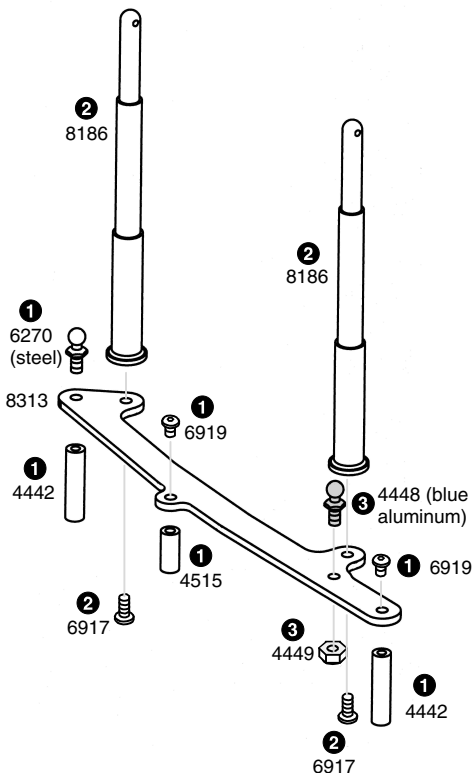

step 5 LEFT SIDE

CHASSIS BRACE/NERF BAR MOUNTING

- Align the #8312 molded nerf bar over the rearmost chassis holes, the large hole of the nerf bar to the rear. Mount the bar to the chassis with the #6292 screw through the forwardmost hole of the bar.
- Push the outside aluminum standoff through the rear hole of the nerf bar. Insert the #6915 screw up through the chassis then into the rear pivot part of the T-bar, and screw it into the center chassis brace standoff tube.
- Secure the outside aluminum standoffs to the chassis with two #7673 screws.

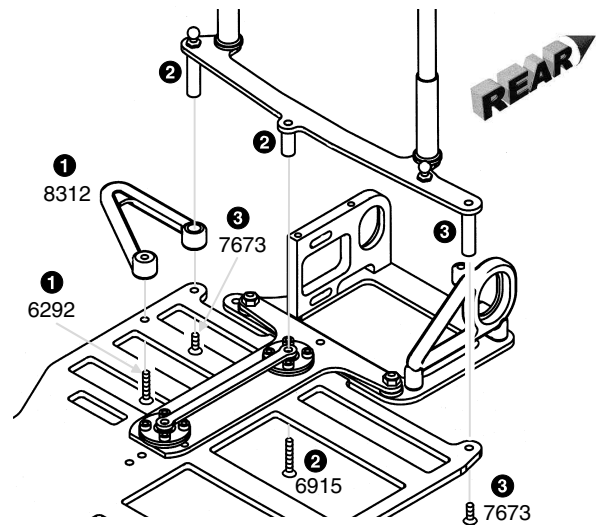

step 6 LEFT SIDE

DAMPENER PLATE ASSEMBLY

- Install the three #4448 ball ends, two #6372 spacers and three #4449 locknuts where shown. **Be sure to use the correct set of mounting holes as shown!**
- Install the #8463 dampener plate to the rear pod using two #6919 screws into the aluminum bulkhead and the longer #6917 screw into the plastic bulkhead.

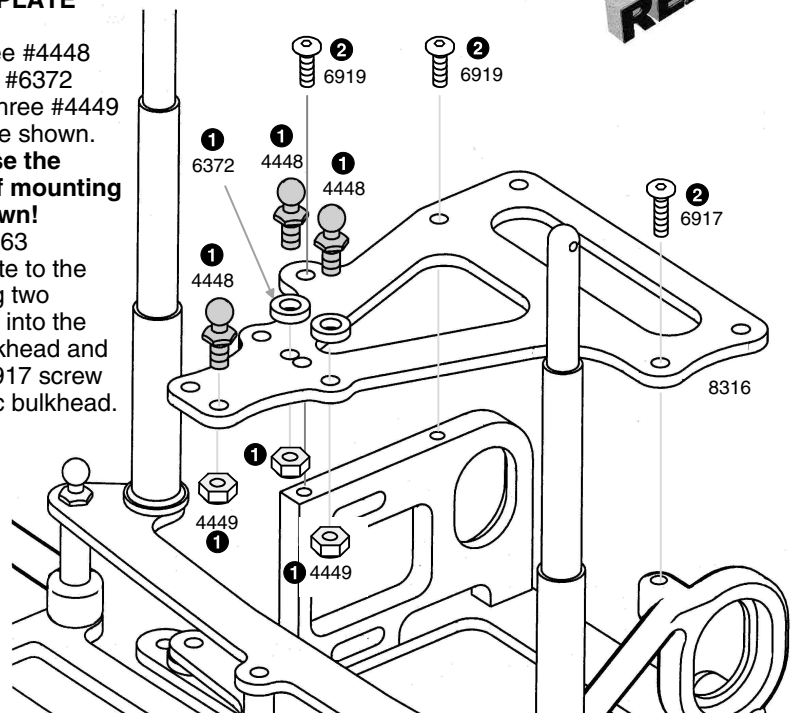

BAG C

REMOVE THESE PARTS FOR:

8018: steps 1-4

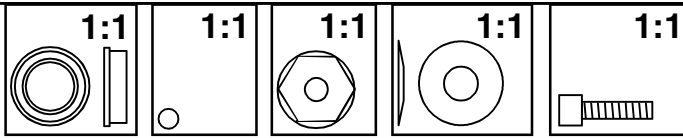

897, qty 4 1/4 x 3/8 flanged bearing
 6626, qty 8 1/8" diff ball
 4185, qty 1 8-32 locknut
 8213, qty 3 Belleville washer
 6924, qty 1 4-40 x 3/8

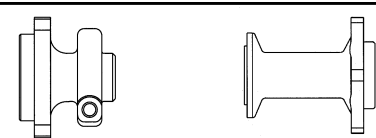

8465, qty 1 left wheel hub
 8467, qty 1 right hand diff/wheel hub
 4355, qty 1 graphite axle
 SILICONE GREASE
 6636, qty 1 silicone grease
 8282, qty 1 diff gear 81 tooth

TOOLS USED

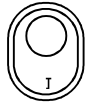
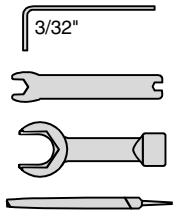

4349, qty 2 ride height adjuster, #1 UP

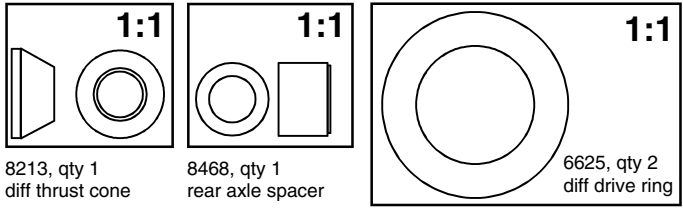

8213, qty 1 diff thrust cone
 8468, qty 1 rear axle spacer
 6625, qty 2 diff drive ring

step 1 LEFT SIDE

DIFFERENTIAL ASSEMBLY

- Find the #4349 adjusters that have a small #1 on them, and insert them into the rear pod. (For more info on these, see the tuning tips later in the manual.)
- Insert two #897 ball bearings into the ride height adjusters as shown.

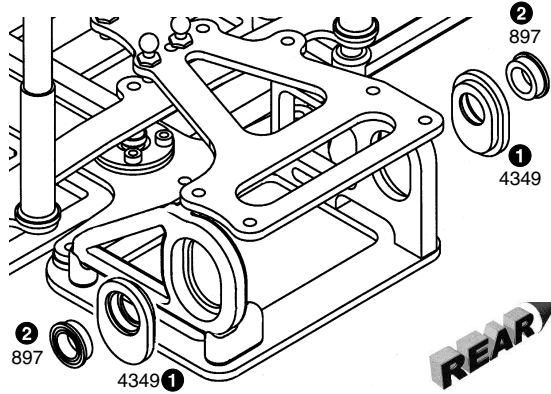

step 2

DIFF GEAR

- Add #6636 silicone grease to the #8282 diff gear ball holes and center hole.
- Push the eight #6626 diff balls into the holes.

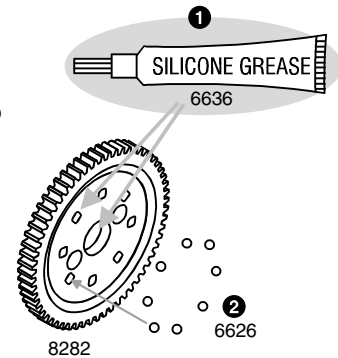

step 3

FINAL DIFF ASSEMBLY

- Hold the #4355 axle upright and slide the #6625 diff ring over the axle and onto the aluminum hub of the axle.
- Slide the #8282 spur gear over the axle and center it on the hub.
- Install the second #6625 diff ring as shown.
- Insert a #897 flanged bearing into each end of the #8467 wheel hub, then slide the wheel hub over the axle.
- Install the #8213 cone so that the smaller end is facing the bearing. Place the three #8213 washers over the axle so that the smaller end faces away from the cone, and secure with a #4185 locknut. We will adjust the diff after we put the wheels on.

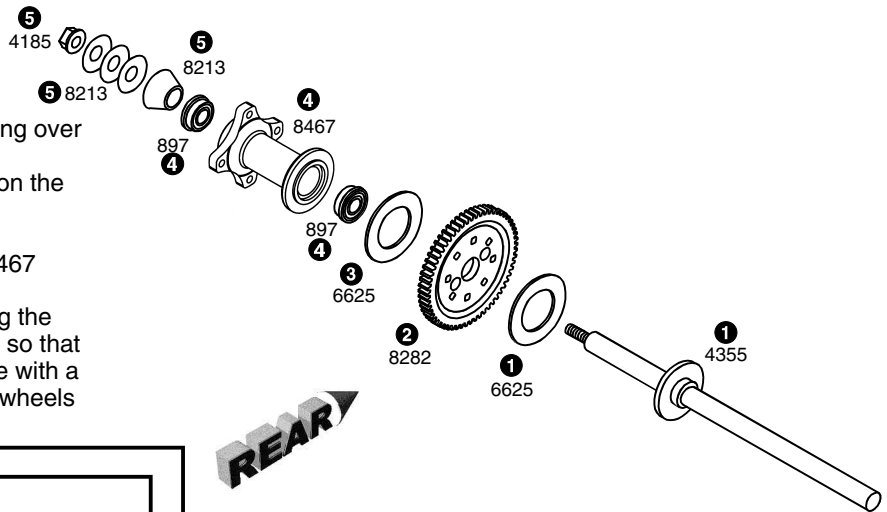

step 4

INSTALLING DIFF ASSEMBLY

- Slide the complete rear axle assembly through the motor bulkhead until it extends through the plastic bulkhead on the other side.
- Slide on the #8468 left hand axle spacer, the shoulder of the spacer facing the bearing.
- Install the #8465 left wheel hub onto the rear axle. Thread the #6924 screw into the hub to tighten it to the axle.

SETTING THE AXLE END PLAY

- Make sure there is a slight (less than 1/64" or .015") amount of axle end play when tightening the left hub clamping screw.

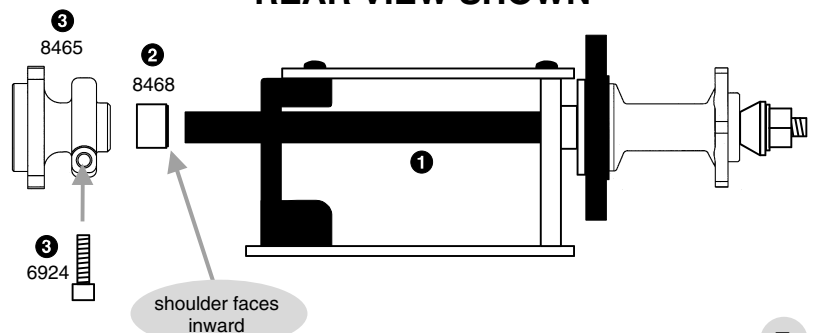

BAG D

REMOVE THESE PARTS FOR:

8018: steps 1-4

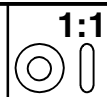

5407, qty 2
red O-ring



6299, qty 2
E-clip

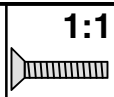

6938, qty 2
4-40 x 1/2
blue aluminum

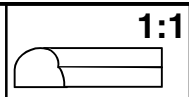

7230, qty 1
ball cup



8456, qty 1
VC foam



8456, qty 1
VC bobbin

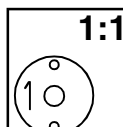

6464, qty 1
shock piston #1

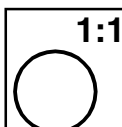

6469, qty 1
large O-ring



5422, qty 1
30 wt
silicone oil

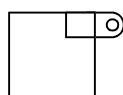

8184, qty 1
shock/antenna
mount

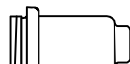

8458, qty 1
macro shock
body

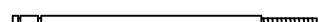

6460, qty 1
shock shaft

TOOLS USED

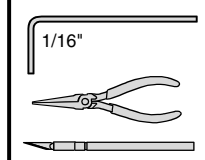

step 1 LEFT SIDE

SHOCK/ANTENNA MOUNT

- 1 Remove the shock cap bushing from the #8184 shock antenna mount.
- 2 Install the mount using two #6938 aluminum screws.

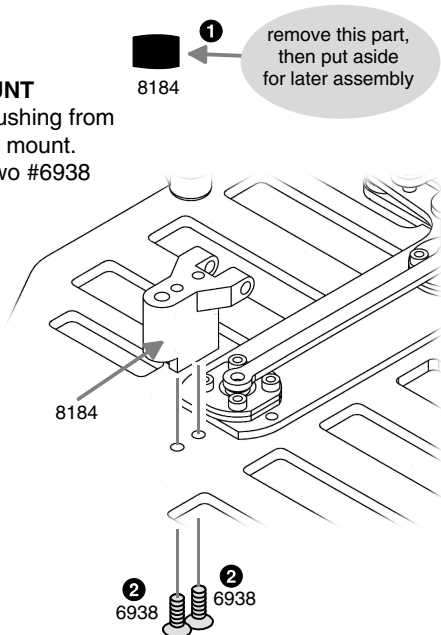

step 2

TRIM SHOCK PISTON

- 1 Burrs interfere with smooth shock action within the shock body. To remove from tree without creating burrs, twist up, not down. Remove one #1 shock piston.
- 2 Remove remaining burrs carefully with hobby knife.

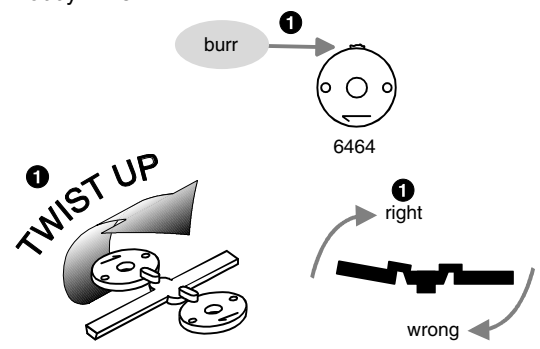

step 3

VC FOAM AND PISTON

Soak the #8456 VC foam with #5422 shock oil and install it onto the #8456 VC bobbin.

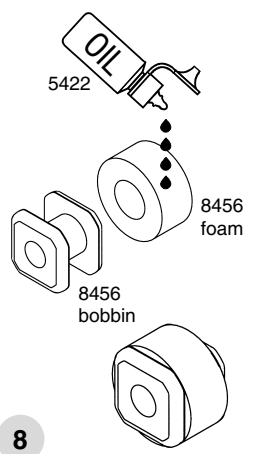

step 4

- 1 Install the #6469 O-ring over the threads of the #8458 shock body.
- 2 Install a #6299 E-clip on either side of a #6464 (#1) piston.
- 3 Slide the assembled VC foam/bobbin over the #6460 shaft and then two #5407 red O-rings. Place a couple of drops of oil on the O-rings.
- 4 Insert the assembly into the shock body and pull the shaft through firmly to seat the VC bobbin at the base of the shock bore.
- 5 Screw the #7230 ball cup onto the end of the shock shaft while holding the shaft with needlenose pliers next to threads.

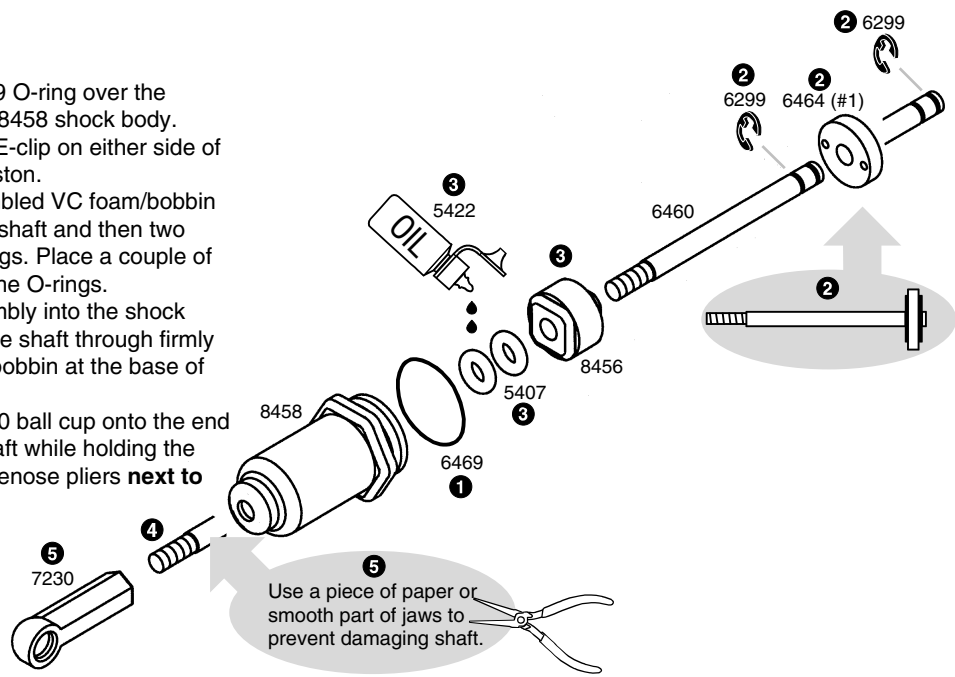

BAG D

REMOVE THESE PARTS FOR:

8018: steps 5-7



8846, qty 1 ea.
spring preload
spacers, 1/4, 1/16



6474, qty 1
spring collar



6474, qty 1
spring cup



7801, qty 1
4-40 x 5/8
blue aluminum



8184, qty 1
shock cap
bushing



5422, qty 1
30 wt
silicone oil



6496, qty 1
spring, silver



6428, qty 1
shock cap

TOOLS USED

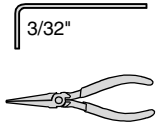

step 5

- 1 Holding the shock upright, fill with oil to the top of the body.

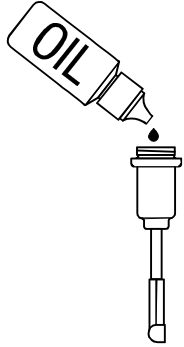

- 2 Slowly move the shaft up and down several times to allow air bubbles to escape to the top.

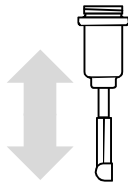

- 3 Refill with oil to the top of the body.



- 4 Push the shaft up until the piston is level with the top of the body. The oil will bulge up above the shock body.

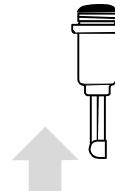

- 5 Fill The #6828 shock cap about halfway with oil and install onto the body. Try to retain as much oil as possible during assembly. The shaft will extend out as you tighten the cap down.

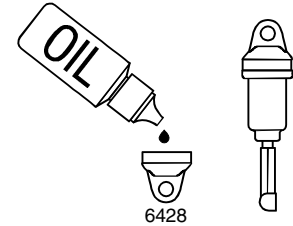

step 6

FINAL SHOCK ASSEMBLY

- 1 Slide the 1/16 and 1/4 preload spacers onto the body.
- 2 Slide on the spring collar, then spring, then compress the spring to add the spring cup.

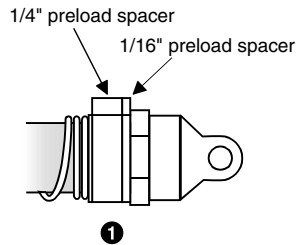

- 2 6474 spring cup (install after spring)

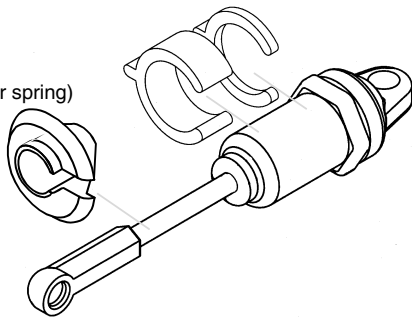

- 1 8846, 1/16 and 1/4"

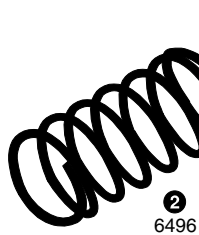

- 2 6474 spring collar

step 7

MOUNT THE SHOCK

- 1 Pick up the small bushing you had removed from the antenna/shock mount and insert it into the shock cap.
- 2 Install the shock cap and bushing into the antenna mount and secure using a #7801 screw.
- 3 Snap the rear of the shock onto the ball end as shown.

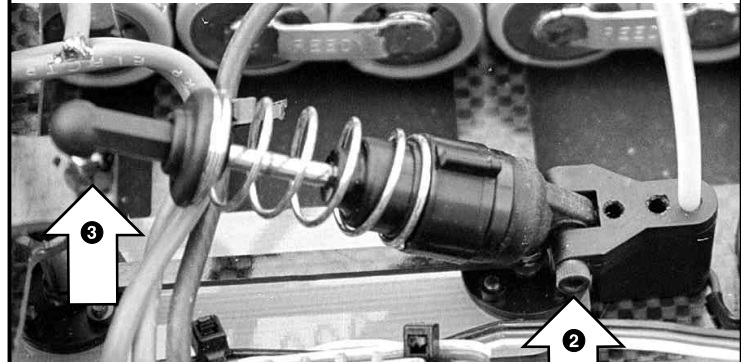
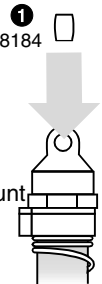
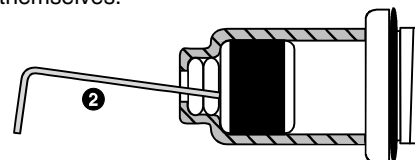

PHOTO DEPICTS FULLY-ASSEMBLED KIT

DISASSEMBLY

- 1 To take out the VC foam/bobbin, unscrew the ball cup and shock cap, and push the shock shaft out.
- 2 Push your Allen wrench tip into the shock bottom and push the bobbin out, as shown. The O-rings should just fall out by themselves.



BAG D

REMOVE THESE PARTS FOR:

8018: steps 8-11

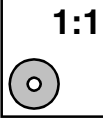

#4473
black VC foam

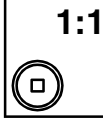

#4473
VC housing

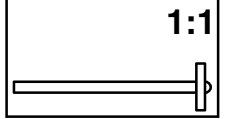

#4472
shock shaft and piston

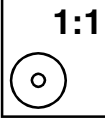

#4473
large washer

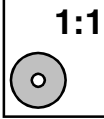

#4473
red O-ring

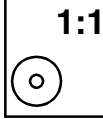

#4473
small washer



5422, qty 1
30 wt
silicone oil

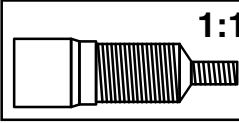

#4471
micro shock body

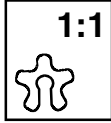

#4473
star clip

TOOLS USED

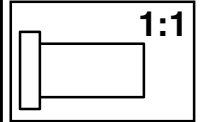

#4473, qty 1
assembly tool

VCS MICRO SHOCK

Team Associated's VCS™ (Volume Compensating System) Micro Shock was developed as a higher-volume, lightweight, constant-travel shock to fit on most road/oval 1:10 and 1:12 cars, and provides consistently smooth, superior dampening without the need for frequent rebuilds.

The VCS™ Micro Shock body is precision-machined from aircraft-quality aluminum, and is externally threaded for convenient spring preload adjustments. Internally, the shock utilizes Associated's exclusive VCS™ volume compensating system, 7075 aluminum shock piston, molded PTFE components, and a precision-ground, case-hardened steel shock shaft which is extremely resistant to bending.

step 8

- 1 Remove the plastic #4473 VC housing from the parts tree.
- 2 Soak the #4473 VC foam with your #5422 shock oil.
- 3 Push the foam into the housing.

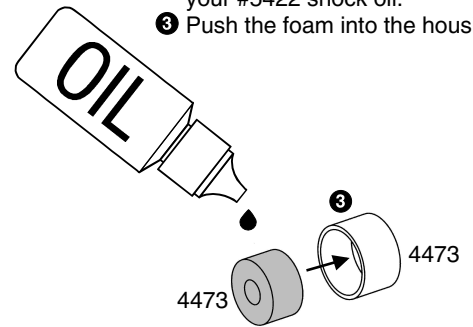

step 9

- 1 Fill #4471 shock body with oil up to the upper groove.
- 2 Insert #4472 shaft/piston all the way to the bottom.

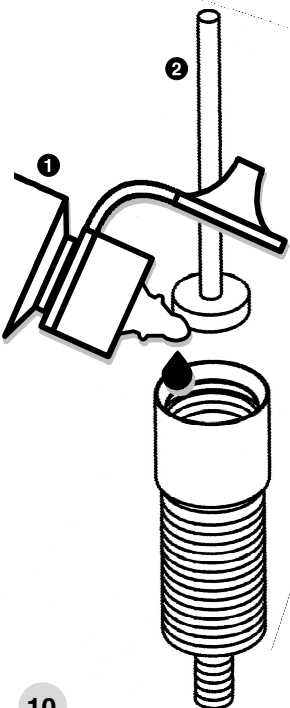

step 10

- 1 Remove the small and large #4473 washers from the parts tree. Remove any flash from the washers.
- 2 Slide the VC housing with foam onto the shaft, housing first (so foam is still seen through the body opening).
- 3 Slide on the following in this order: smaller washer, red O-ring, larger washer, then the star-shaped clip.

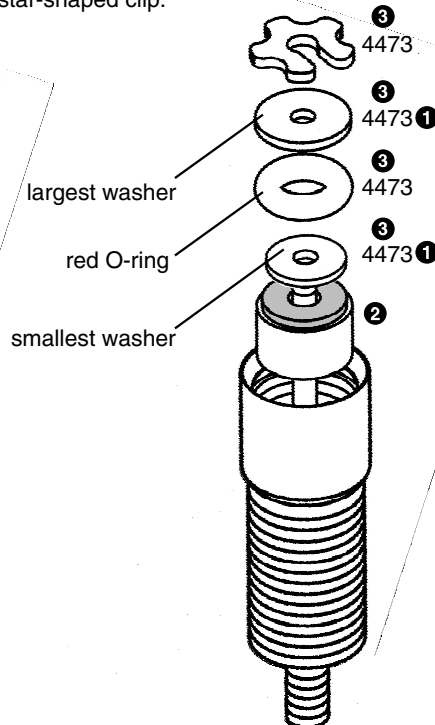

step 11

Use the assembly tool to push all the parts down into the body until the clip snaps into the groove. When you remove the tool, the shaft will push out somewhat if everything snapped into place correctly. **Make sure the clip snaps into the groove completely.**

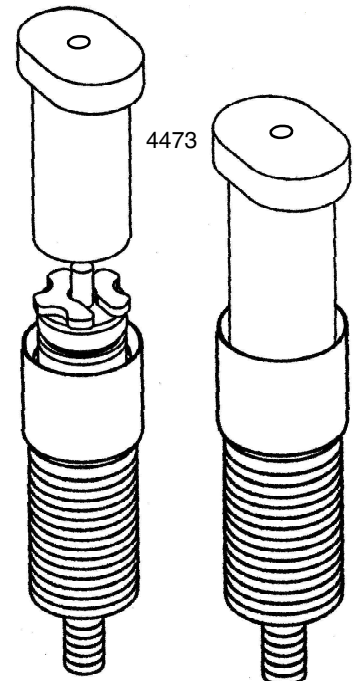

BAG D

REMOVE THESE PARTS FOR:

8018: steps 12-14

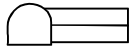

#6274, qty 4
ball cup



#4473, qty 2
spring
adjusting nut



#4474, qty 2
shock shaft end



#6951, qty 2
set screw



#8451, qty 2
silver spring

TOOLS USED

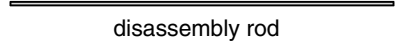
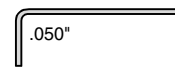

disassembly rod

step 12

- 1 Remove the assembly tool and screw on the ball cup where shown.
- 2 Screw the #4473 spring adjusting nut onto the shock body threads, flange first, as shown.

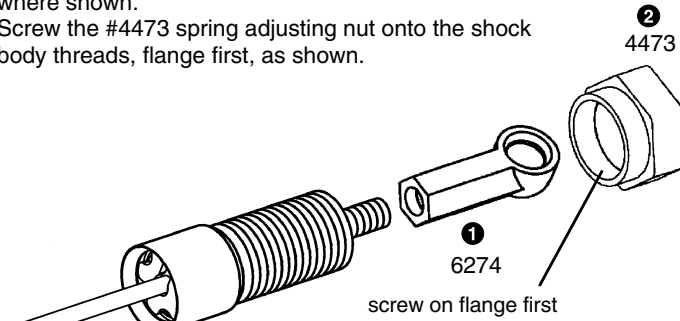

step 13

- 1 Slide the spring over the body and up against the #4473 adjusting nut.
- 2 Screw the #6274 ball cup onto the #4474 shock shaft end.
- 3 Tighten the #4474 shock shaft end to the shaft with the #6951 set screw.

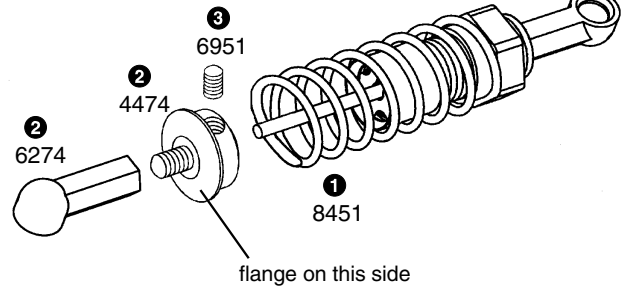

step 14

- 1 Pop the #6274 ball cups on the ball ends of your kit.
- 2 Turn the spring adjusting nut to adjust spring tension.

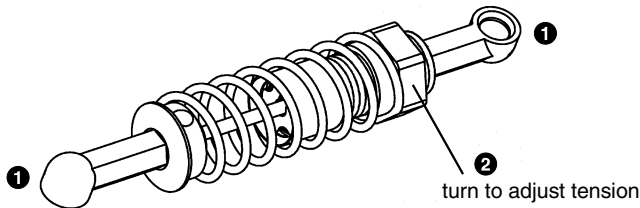

DISASSEMBLY

- 1 To remove the parts from inside the shock, first loosen the #6951 set screw of the #4474 shock shaft end, then slide off the shaft end and spring.
- 2 Now carefully insert your disassembly rod into one of the rounded grooves of the star clip and pop it out.

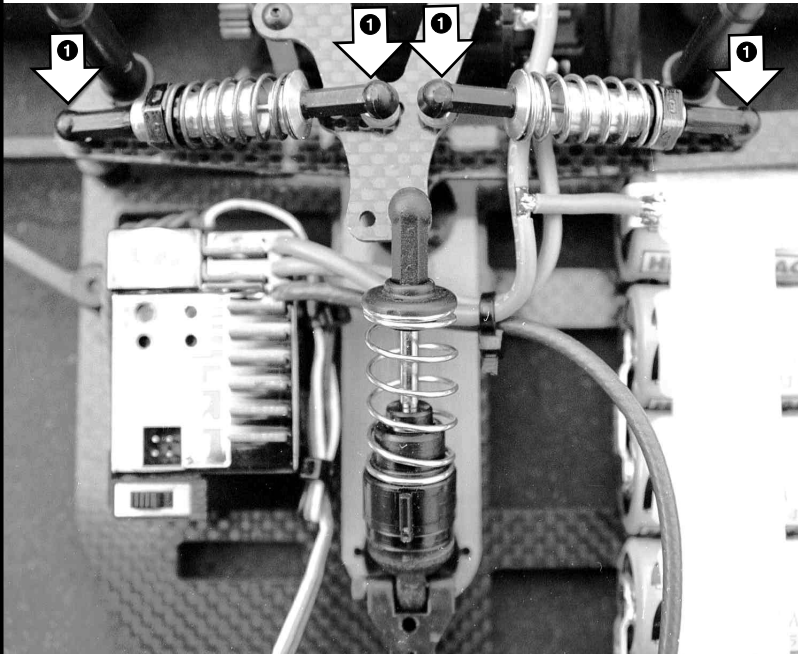
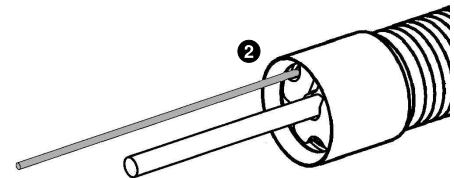

PHOTO DEPICTS FULLY-ASSEMBLED KIT

BOX

REMOVE THESE PARTS FOR:

8018: steps 1-2



6902, qty 4
3/16 x 5/16
flanged ball bearing

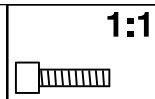

6924, qty 8
4-40 x 3/8

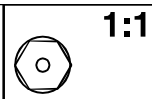

6222, qty 2
4-40/5-40
nylon locknut

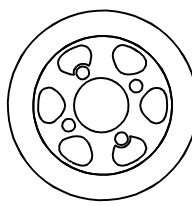

#8166, qty 2
rear wheel/tire

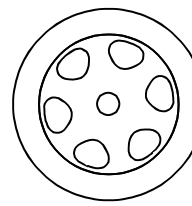

#8146, qty 2
front wheel/tire

TOOLS USED

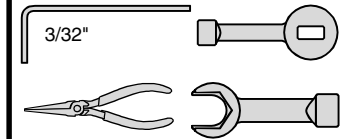

step 1 LEFT SIDE

MOUNTING REAR TIRES

- 1 Install both #8166 rear tires to the hubs with four #6924 screws into each wheel hub.

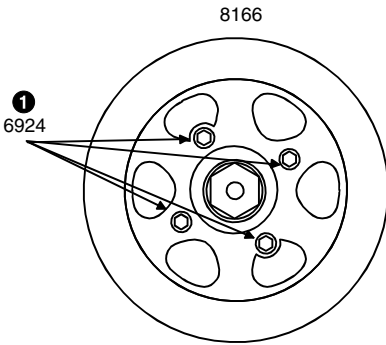

SIDE VIEW SHOWN

MOUNTING FRONT TIRES

- 2 Put a #6902 flanged ball bearing into each side of the #8146 front wheels.
- 3 Slide the wheel on and secure it with a #6222 nut. Install the other wheel the same way.

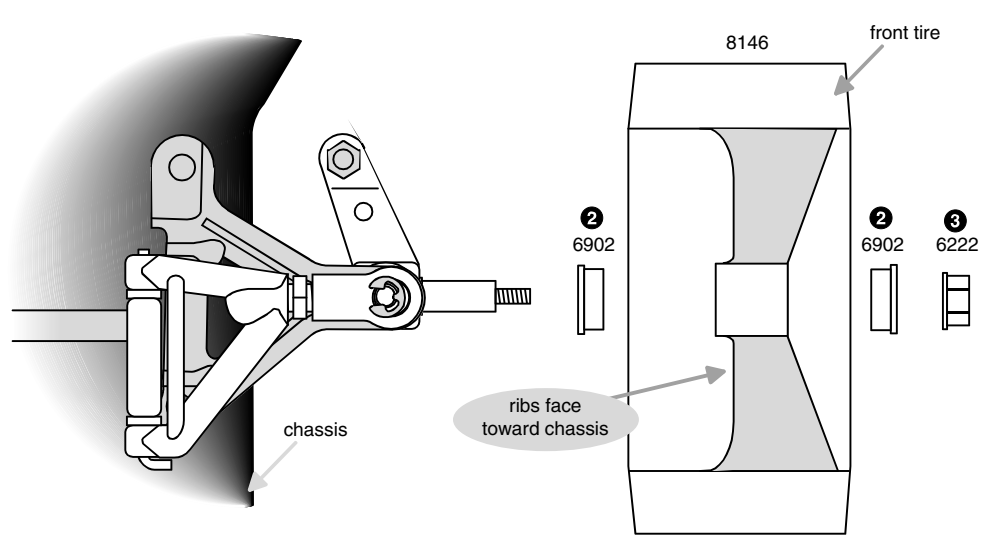

TOP VIEW SHOWN

step 2

DIFFERENTIAL ADJUSTMENT

- 1 While holding both rear wheels with your hands as shown, use your right thumb and index finger to try and rotate the spur gear. The spur gear should be very difficult to rotate. If you can rotate it easily, then tighten the #4185 11/32" nut at the end of the axle, a little at a time, until the spur gear is difficult to rotate.

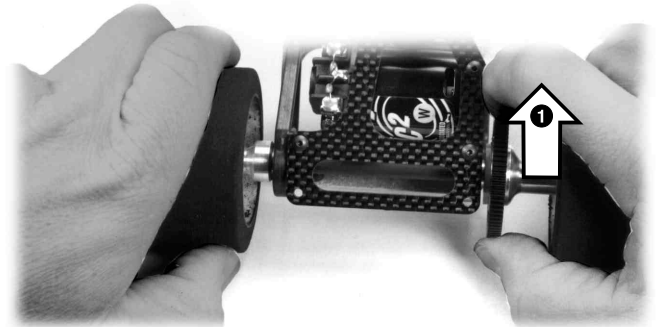

BAG E

REMOVE THESE PARTS FOR:

8018: steps 1-2



4449, qty 2
4-40 locknut

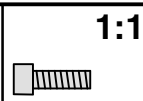

4145, qty 4
4-40 x 5/16
blue aluminum

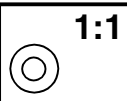

7337, qty 4
#4 washer

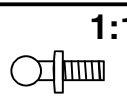

4448, qty 2
ball end

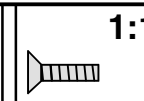

6934, qty 2
4-40 x 3/8
blue aluminum

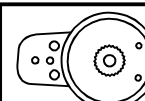

8445, qty 1
servo saver

8445, qty 1
servo saver
screw

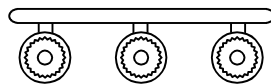

8445, qty 1
servo saver
adapter

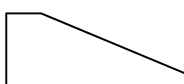

8435, qty 2
servo mounting block

TOOLS USED

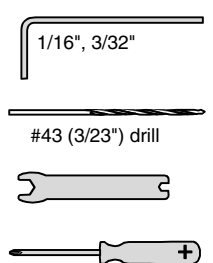

step 1

DRILLING STEERING SERVO BLOCKS

- 1 For the 1:10 scale cars we recommend you use a larger, more standard size servo. This would be:

Airtronics:
94102 or 94737

Futaba:
S148 or 9101

HiTec:
HS225BB, HS235AG, or HS525AG.

- 2 Drill two holes with a #43 (or 3/32") drill into the #8435 servo blocks where shown for your servo size. **DO NOT drill at an angle to the slanted face!**



Airtronics:
94102 or 94737
Futaba:
S148 or 9101
HiTec:
HS225BB,
HS235AG, or
HS525AG

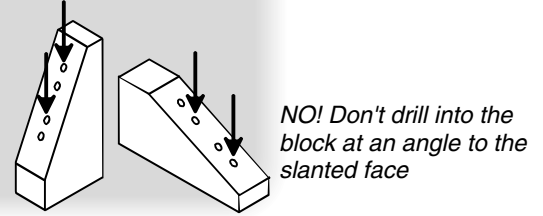
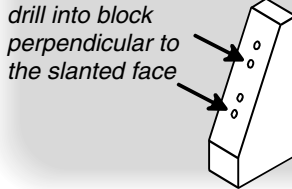
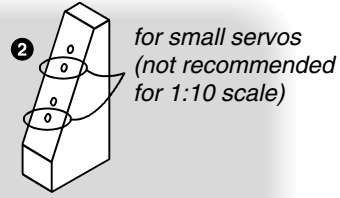

step 2

MOUNTING THE SERVO

- 1 Secure the servo to the blocks with four #4145 blue aluminum screws and four #7337 #4 washers.

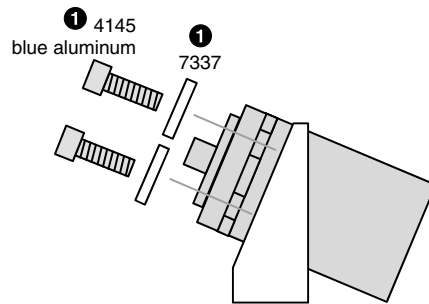

ASSEMBLING THE SERVO SAVER

- 2 Thread two #4448 ball ends into the front side of the #8445 servo saver. Secure the ball ends with the #4449 locknuts.

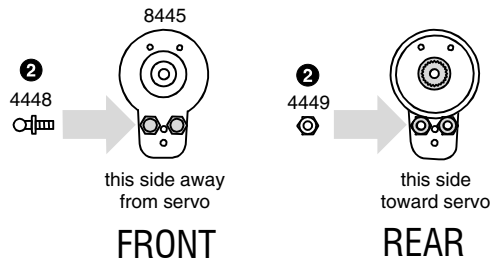

- 3 Try the three #8445 adapters on the servo until you find one that fits. Push that adapter into the servo saver.

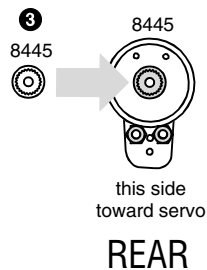

MOUNTING THE SERVO ASSEMBLY

- 4 Mount the servo saver to the servo with the #8445 screw. **Note:** If you have a metal gear servo, use the stock mounting screw.
- 5 Mount the servo mounting blocks to the chassis with two #6934 screws. **Be sure to use the forward set of holes in the chassis.**

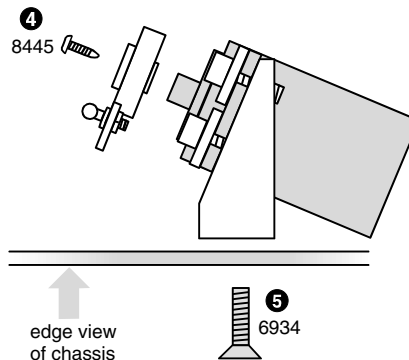

BAG E

REMOVE THESE PARTS FOR:

8015: steps 3-4

8016: steps 3-4

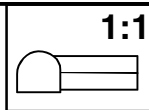

6274, qty 4
ball cup

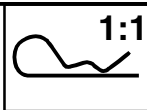

6332, qty 4
body clip

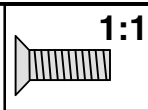

6942, qty 4
8-32 x 1/2
blue aluminum

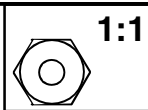

3438, qty 2
8-32 locknut

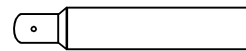

8304, qty 2
front body mount

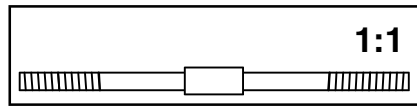

1405, qty 2
blue titanium steering turnbuckle

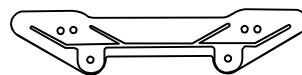

8303, qty 1
front bumper

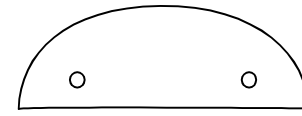

8305, qty 1
foam bumper

TOOLS USED

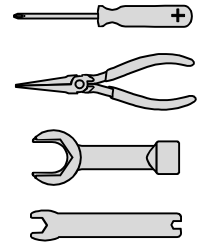

step 3

STEERING LINKAGE

- 1 Install the plastic ball cups onto the #1405 titanium steering turnbuckles. Match the length of the turnbuckles to the actual size picture below.
- 2 Snap one ball cup onto the ball end on the servo saver. Snap the opposite end on as shown. Install both turnbuckles.
- 3 When you are adjusting your turnbuckles, always make sure that the servo saver is pointing straight down.

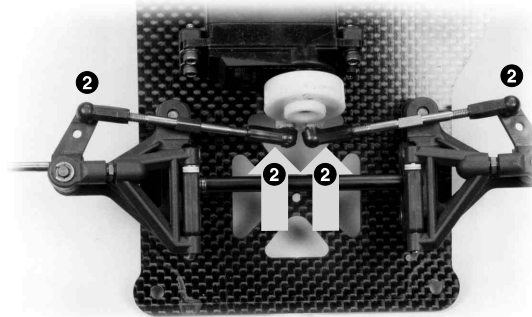
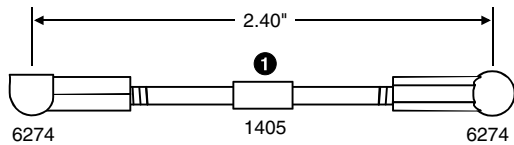

step 4

FRONT BUMPER

- 1 Bolt the #8303 front bumper to the front of the chassis with two #6942 blue screws from underneath and two #3438 locknuts on top.

FRONT BODY MOUNT POSTS

- 2 Tighten the #8304 body posts to the bumper where the two gray arrows indicate with two #6942 blue screws from underneath.
- 3 Cut and trim the foam bumper with a sanding block to fit the body of your choice and slide it over the two body mounts.
- 4 Add #6332 body clips to the front posts and the rear.

Your kit includes an extra hole for an optional body post for those bodies that require support for the hood

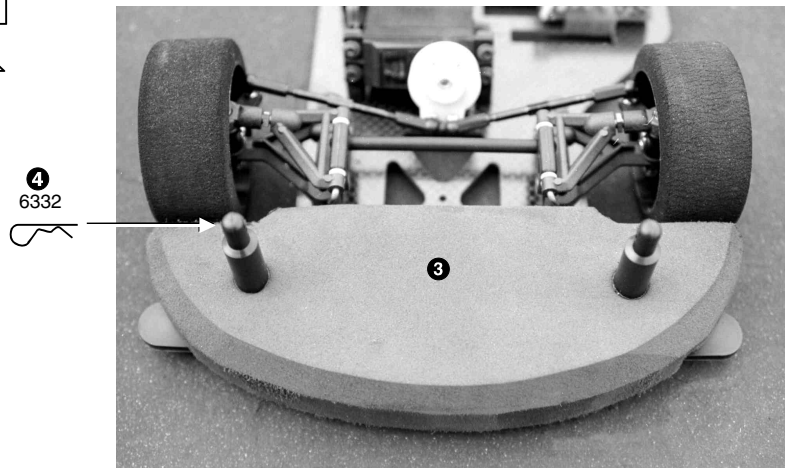
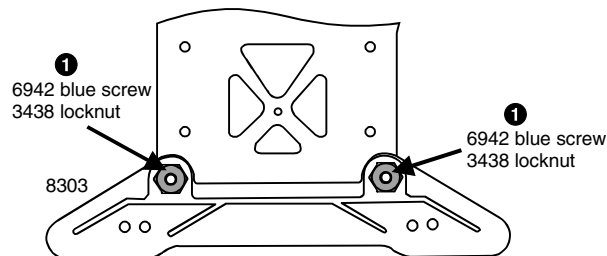
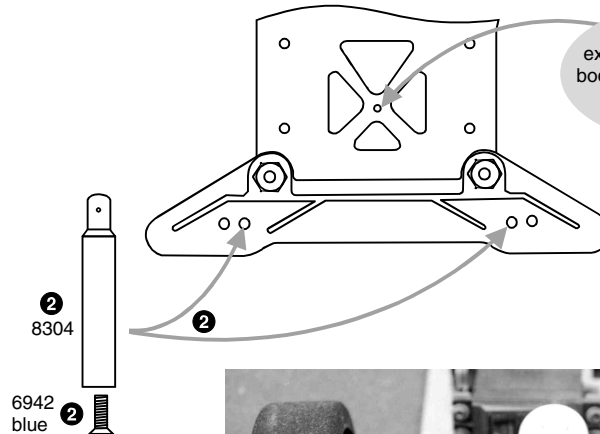

BAG E

REMOVE THESE PARTS FOR:

8018: steps 5-6

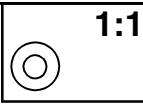

7337, qty 2
washer
gold, steel

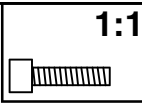

6515, qty 2
3mm x 10mm
gold

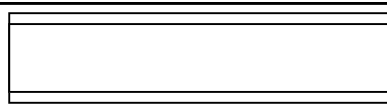

6726, qty 1
servo tape strip

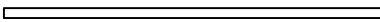

3716, qty 1
antenna



3716, qty 1
antenna cap

TOOLS USED

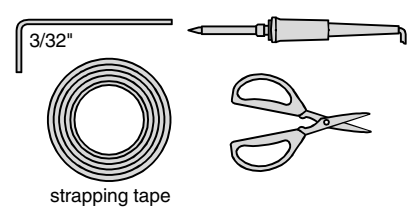

step 5

PINION GEAR INSTALLATION

- Slide the pinion gear onto the shaft so that the gear is 1/16" away from the motor can. Tighten the set screw to hold it in place. Teeth side should be farthest from can.

MOTOR INSTALLATION

- Insert the motor into the rear pod assembly as shown, the pinion gear coming through the right side motor bulkhead.
- Tighten the motor to the bulkhead with two #6515 screws and two #7337 gold washers.
- Set the gear mesh so that there is very little play between the spur and pinion gear. **Note:** If the gear mesh is too tight, you can lose significant power.

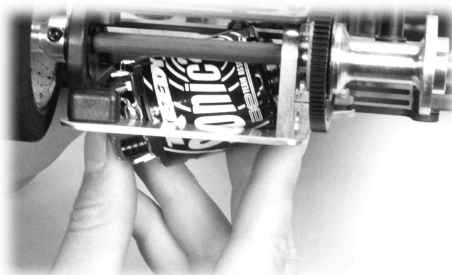

2



MOTOR AND PINION GEAR ARE NOT INCLUDED IN KIT

step 6

ELECTRICAL INSTALLATION

- Solder your single cell batteries together with battery braid or battery bars. Solder plus (+) to minus (-).
- Hold the batteries to the chassis with strapping tape. Wrap the tape over the batteries, through the chassis slot, underneath the chassis, and up again through another slot, several times.
- Cut the #6726 servo tape to fit the bottom of the speed control and receiver. Peel the backing from the servo tape and place them where shown in the drawing.
- Insert the #3716 antenna into the antenna mount. Slide your receiver antenna wire through the antenna and secure the wire with the antenna cap.
- Now connect the electronic speed control and steering servo to your receiver **according to your radio or ESC instructions**, then connect the motor to the ESC and battery.

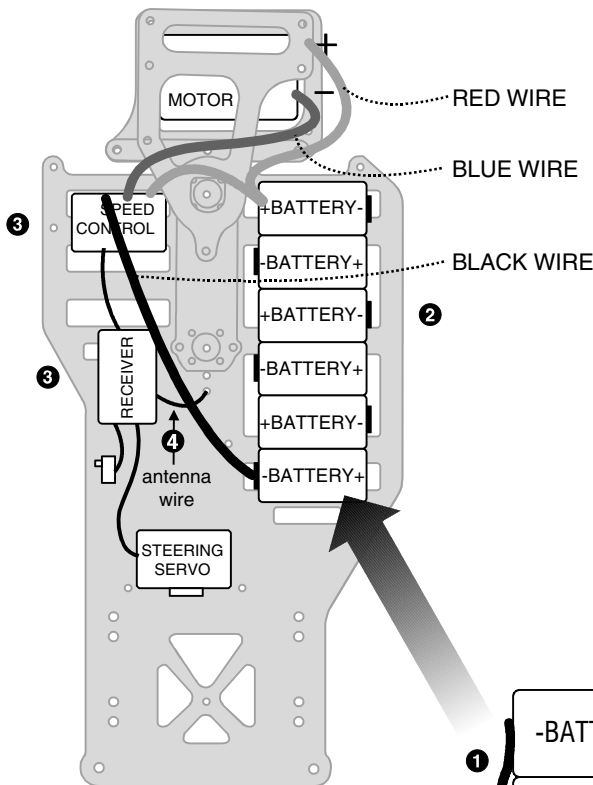

TOP VIEW

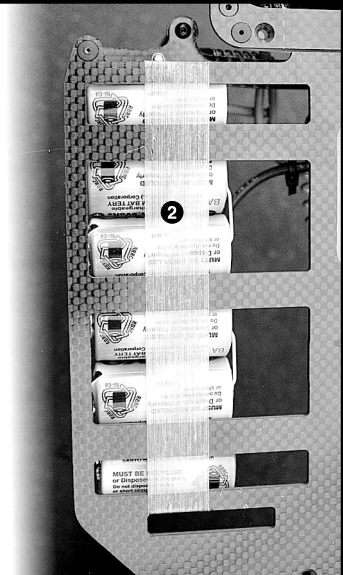

BOTTOM VIEW

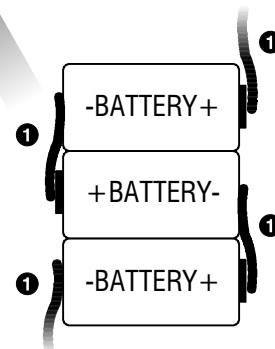

ELECTRICAL ITEMS ARE NOT INCLUDED IN KIT