

# 1:10 SCALE NITRO TRUCK INSTRUCTION MANUAL

# RC10GT

**PART 1**



## RC10GT'S COME OUT ON TOP--AGAIN!

Billy Easton and his RC10GT win the 1999 Silver State Nitro Challenge; Dvorak's GT TQ's!  
8 out of 10 RC10GT's in the A-Main!



Mark Pavidis  
'94 Electric  
Champion  
NORRCA  
World Cup

Mark Pavidis  
'94 Gas  
Champion  
NORRCA  
World Cup

Mark Pavidis  
'96 Electric  
Champion  
NORRCA  
World Cup

Richard Saxton  
'96 Gas  
Champion  
NORRCA  
World Cup

Richard Saxton  
'98 Electric  
Champion  
NORRCA  
World Cup

Richard Saxton  
'98 Gas  
Champion  
NORRCA  
World Cup



MADE IN THE USA BY  
©1999 Associated Electrics, Inc.

Richard Saxton's World Cup winning RC10GT

## **ABOUT THE RC10GT**

When Associated first introduced the RC10T truck in early 1991, it helped set a new standard for 1:10 scale electric racing trucks. Until the release of the RC10T, most of the early truck kits were buggies with truck parts installed. The suspension was still limited because they were designed according to buggy rules, which are different from truck rules. The RC10T was designed from the ground up to be a truck so we could take advantage of the differences in the rules and components that apply to the trucks and not to the buggies. Our success with the RC10T has proven itself on the race track. In the short time the truck has been out it has won the 1991 and 1992 NORRCA Nationals and the 1992 and 1993 ROAR Nationals. Associated has since progressed to new technology with its RC10T2 and T3.

The RC10GT gas truck was released to meet the need of those racers who were converting their electric trucks to gas. Although the GT has been released as early as 1993, it has never ceased to be a dominant force in the R/C racing scene. Under the skillful hands of Mark Pavidis and Richard Saxton, it continues to win the NORRCA Gas Truck Nats and other national races. Important advances in technology, which were borne out in intensive testing in real-world race conditions with the RC10T, T2 and T3, were transferred to the RC10GT kits to enhance an already powerful machine born to win! A brief listing of those changes will be found right after the shock section.

## **TOOLS**

### **Tools supplied in kit:**

- Allen wrenches, .050", 1/16", 5/64", 3/32".
- Shock assembly tool.
- Associated shock, turnbuckle and axle nut molded wrenches.

### **Extra tools needed:**

- 1/8" flat blade screwdriver. (*Do not use a power screwdriver to install screws into nylon parts. You can too easily strip out the hole.*)
- #2 Phillips screwdriver.
- A hobby knife, such as an X-acto, with pointed blade.
- 5/16" nut driver or deep reach glow plug wrench.
- Needle nose pliers.
- Small hammer.
- A ruler with decimal inches or metric measure.
- Locktite threadlock #242.
- Blue Super Glue (cyanoacrylic adhesive)

### **Extra parts needed:**

- 2 channel R/C surface radio system.
- .12 ci. glow fuel R/C engine (with or without pull start).
- Receiver battery pack.
- Battery charger (if receiver pack is ni-cad batteries then you will need a charger for this pack).
- Glow plug igniter.
- Fuel tank bottle for refueling tank.
- Starter box or electric hand starter with car starter donut (for non pull start engines).
- 12 volt battery for starter system (for non pull start engines).
- R/C car glow fuel (we recommend Blue Thunder or O'Donnell racing fuels).

## **BEFORE BUILDING**

### **Please observe these notes when building your kit.**

- Open the parts bags when the step specifies, not before.
- Don't mix parts from one bag with parts from another bag, because this manual refers to parts from specific bags.
- Check the bags for kit updates that replace the instructions. For your convenience, they are labeled "Supplementary Sheets" at the top.
- This manual has been revised and updated to incorporate the many enhancements to the GT over the years. You will notice several steps and pages skipped throughout the manual. Those steps are no longer needed.
- The driver's side in the instructions refers to the left side of the truck with the truck's front pointing away from you. (Sorry, England!)
- Read the words AND see the pictures. The pictures alone do not convey the whole story.
- Save this manual. The parts numbers and names will help you when ordering new parts.
- Colors and appearance in photos do not always match actual parts.



Associated Electrics, Inc.  
3585 Cadillac Ave.  
Costa Mesa, CA 92626-1401  
web: <http://www.teamassociated.com>

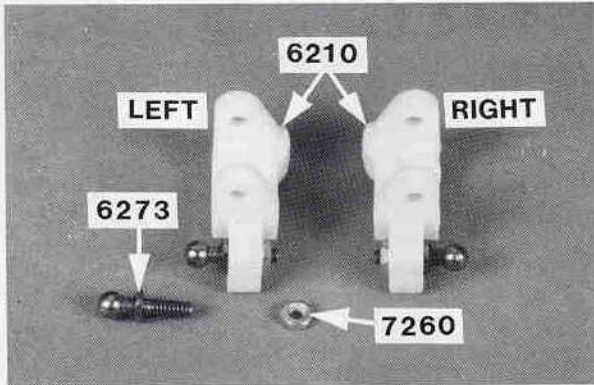
©1999 Associated Electrics, Inc.



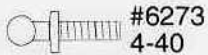
All kits follow the instructions below until otherwise indicated.

## FRONT END ASSEMBLY

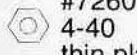
**Fig. 1** Read pages four and five entirely before proceeding! From bag #6-14 remove two #6273 long ball ends and two #7260 4-40 small thin plain nuts. Now open bag #7-1 and remove the #6210 30° front carrier blocks. (1) Remove the carrier blocks from the small molded runner with your X-acto® knife. (2) Screw one of the #6273 ball ends into each carrier block as shown. (3) Thread on the #7260 thin plain nuts. (A 3/16" nut driver installs the steel ball ends easier.)



**Fig. 1**

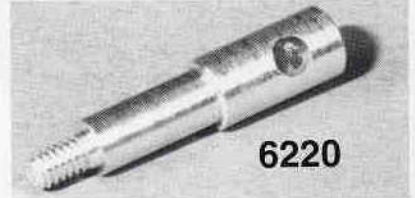


#6273  
4-40

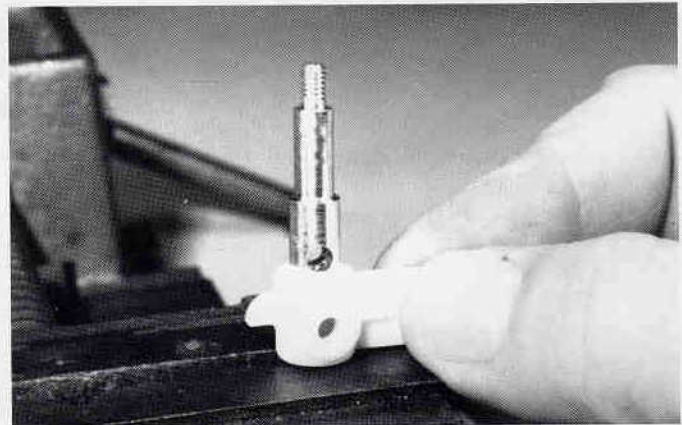


#7260  
4-40  
thin plain nut

**Figs. 3 & 3A** You will find the two #6220 aluminum inline front axles in bag #7-1. Your axles will look like fig. 3. We are going to install one axle in each #6221 nylon steering block (fig. 3A), making sure that the hole in each axle lines up with the hole in the steering block. The parts should push together with your fingers; if not, you may use a 1/4" nut driver to fit over the threaded end of the axle and then push the axle into the steering block. **WARNING!** Remember the threads on the end of the axle are aluminum and can easily be damaged by the nut driver. Repeat the process for the second axle and steering block.

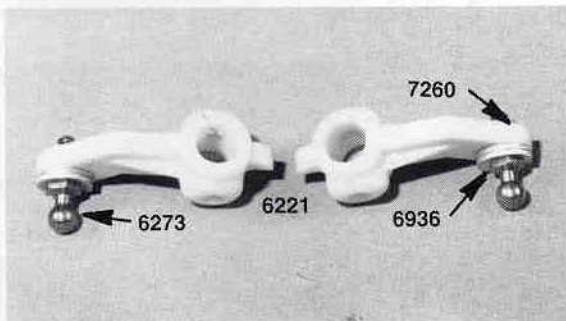


**Fig. 3**



**Fig. 3A**

**Fig. 2** Go to bag #7-1 again and remove the two #6221 nylon steering blocks. From bag #6-14 remove two of the #6273 long steel ball ends, two #7260 4-40 thin plain nuts, and four #6936 #4 aluminum flat washers. (1) Place two washers onto each steel end. (2) Screw one ball end into each steering block as shown. (3) Thread on the plain nut from the back side.



**Fig. 2**



#6936  
#4 flat washer  
aluminum

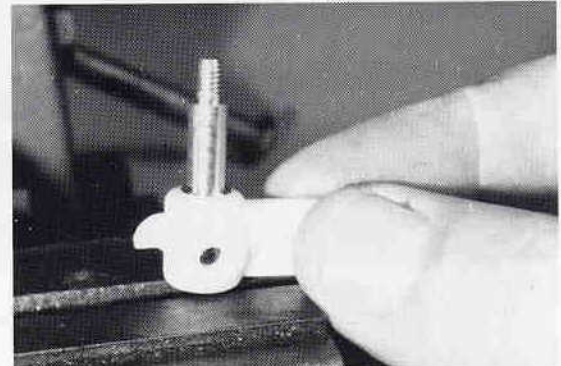


#7260  
4-40  
thin plain nut



#6273  
4-40

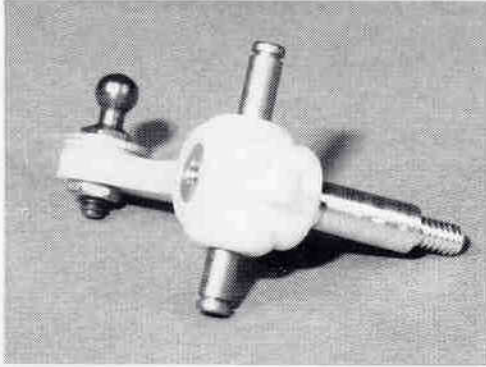
**Fig. 4** The axle is round and will be fairly tight in the steering block so align the hole in the #6220 axle with the hole in the #6221 nylon steering block as you are assembling the parts. **WARNING!** Do not use pliers on the bearing surface of the axle for this can damage the axle surface so the bearings no longer fit. The larger diameter of the axle will still be sticking out of the steering block slightly, but that's O.K. Just make sure the holes line up.




**Fig. 4**



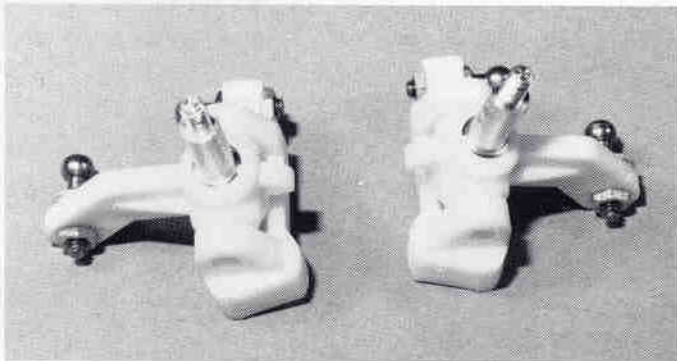
□ **Fig. 5** In bag #7-1 you will find two #6223 kingpins. Match the pins to the actual size drawing at the bottom of the photo. We now want to check that each kingpin will go through both steering blocks and axles. If you don't do this it will be almost impossible to get the kingpin to go through the #6210 carrier block and the steering block and axle when we assemble them. Once you have checked the fit of the kingpins, remove them again.



**Fig. 5**

 #6223


□ **Figs. 6, 7, 7A, & 8** (1) Take the two #6210 carrier blocks and install the steering blocks and axles into each one. Both ball ends will be on the same side when installed correctly and the raised side of the angle on the bottom of the #6210 carrier block will be away from the ball side. (2) Now reinstall one of the #6223 kingpins thru each of the carrier block/axle assemblies as shown in 7 and 7A, trying to center the kingpins. Fig. 8 shows a package of #6299 1/8" E-clips that came from bag #7-1. (3) Remove two e-clips and install one into the grooves of the kingpin at each end. (4) Now take out two more E-clips and install them on the other kingpin.




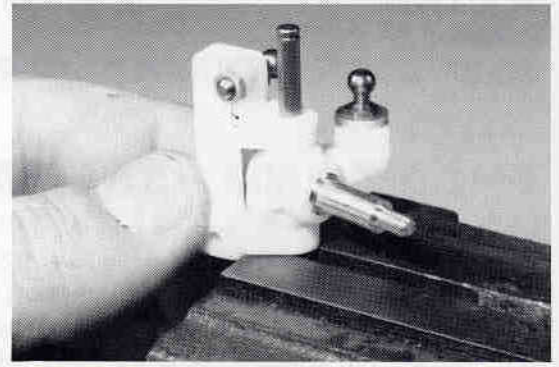
*right side*

*left side*

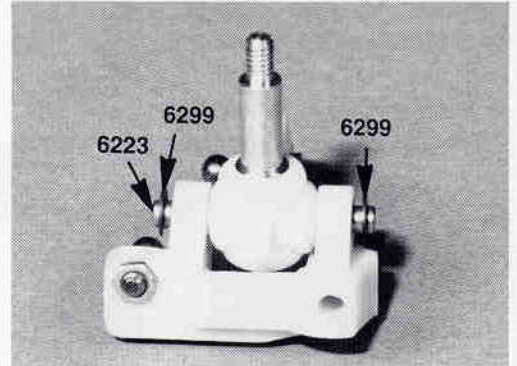
**Fig. 6**

 #6223

 #6299  
e-clip  
1/8 shaft



**Fig. 7**



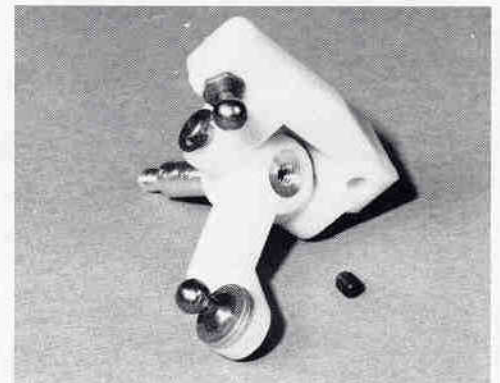
**Fig. 7A**




*E-clips.*

**Fig. 8**

□ **Fig. 9** In bag #7-1 you will find two small #6951 4-40 x 1/8" set screws. Locate your #6950 tool bag, which is in the large master parts bag. Take out the smallest Allen wrench (.050") which we will use to install the two set screws into the #6221 aluminum front axles. Rotate the steering blocks in the block carriers so you can see the threaded hole on the back side of the #6221 aluminum front axle. Slide one of the set screws onto the Allen wrench and carefully thread the set screw into the back of the front axle until it tightens down on the kingpin as shown in fig. 9. Do the same with the other axle assembly.



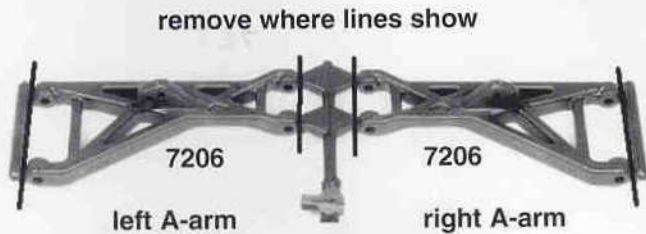
 #6951  
set screw

**Fig. 9**

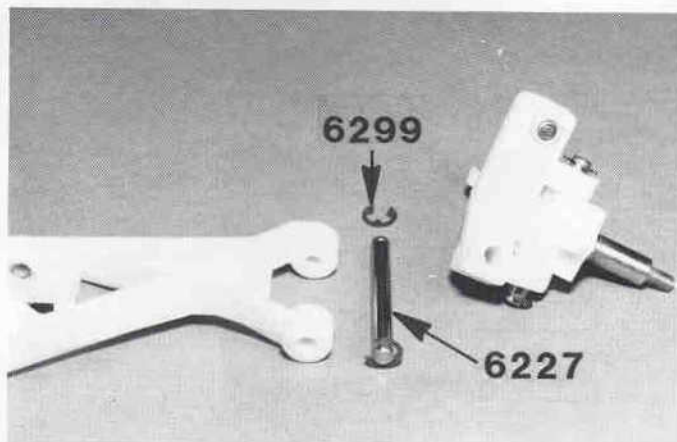


□ **Figs. 10, 11, 11A & 11B** Remove the bag containing the black suspension arms. Remove the #7206 front arms that look like fig. 10. This photo shows you which arm is right and which is left and it shows you where to trim the runners from the arms. The material is tough enough that you must remove the arms with a pliers. Then trim any remaining runner pieces with your X-acto® blade.

(2) From bag 7-1 locate the two #6227 outer hinge pins (match them against the scale drawing). Install one of the hinge pins through the holes in the outside end of the A-arm, hold the pin, and see if the arm will swing freely on the pin. *Racer's tip: Most racers keep a .126" and a #30 (.1285") reamer in their toolbox to free up or clean A-arm holes so they will pivot smoothly.* (3) Using the same pin, check the fit in the #6210 left front carrier block. We want the pin to fit tight, so do not ream out this hole. (4) Now remove the outer hinge pin and install the left carrier block assembly to the left outer A-arm location using the #6227 hinge pin. (5) Install a #6299 E-clip on each end of the hinge pin. Both of the ball ends will be on the back (or straight) side of A-arm when installed correctly, and the #6210 carrier block will be angled towards the front, as shown in fig. 11A. (6) Now repeat the above steps for the right side A-arm; it will be a mirror image of the left.



**Fig. 10**



**Fig. 11**

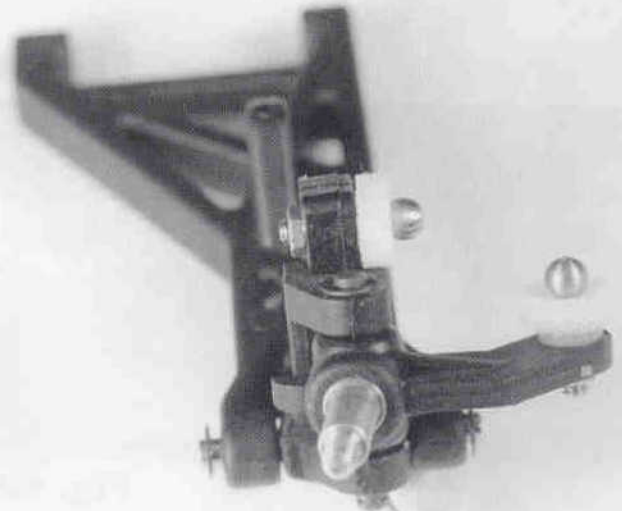
▬ #6227

⊕ #6299  
e-clip  
1/8 shaft



#7206 left arm

**Fig. 11A**



**Fig. 11B**

□ **Figs. 12, 13 & 13A** Go back to bag 7-1 and remove the #7207 front bulkhead, the #7208 front bulkhead aluminum support, and the two #7209 front inner hinge pins. Match the hinge pins to the scale drawing. Fig. 12 shows you the front bulkhead alone to make it easier to identify the front and rear sides of the bulkhead. Check the fit of the hinge pins in the A-arms the same way we did for the front A-arms. Free them up if necessary. We want the pins to be tight in the front bulkhead, but free in the arms.

(1) Starting with the left A-arm, install the inner hinge pin through the back half of the A-arm and the #7207 front bulkhead. (2) Now line up the #7208 aluminum bulkhead support between the front side of the bulkhead and the front of the left A-arm (fig. 13A) and push the hinge pin the rest of the way through. (3) Secure the hinge pin with a #6299 E-clip on each end. (4) Now assemble the right side suspension the same way. Fig. 13A shows the front bulkhead assembly completed.

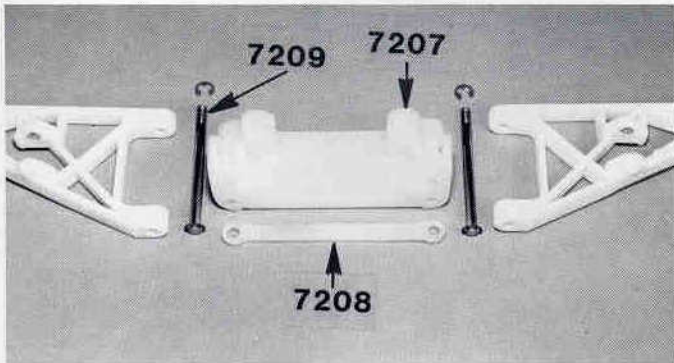
▬ #7209

⊕ #6299  
e-clip  
1/8 shaft E-clips are found in bags #7-1,  
#7-8, #7-9 and #7-10.

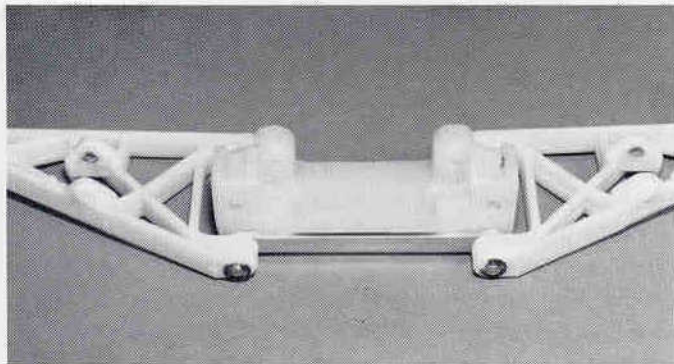




**Fig. 12**



**Fig. 13**



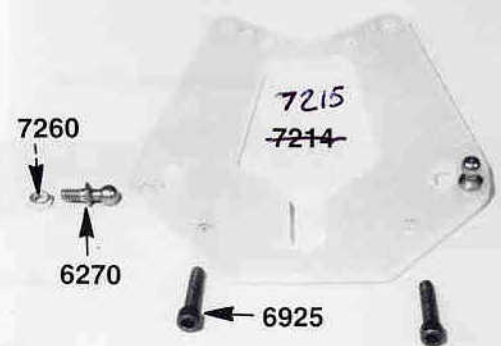
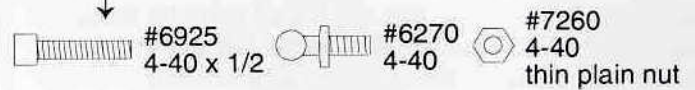
**Fig. 13A**

□ **Figs. 14, 15 & 16** From bag #6-14 remove two #6270 short steel ball ends and two #7260 4-40 thin plain nuts. Now take the #7214 fiberglass front shock strut and two #6925 4-40 x 1/2" SHCScrews from bag #7-1. (1) Install the ball ends in the location shown (if your strut has two holes use the lower hole). At this time it does not matter which side of the shock strut you use. (2) Tighten the ball ends, then install and tighten the two plain nuts on the exposed threads of the ball ends. (3) Go back to your #6950 tool bag and take out the largest Allen wrench (3/32"). (4) Install the #7214 shock strut using the two 4-40 x 1/2" SHCScrews. Mount the shock strut on the back side of the #7207 front bulkhead, making sure that the ball

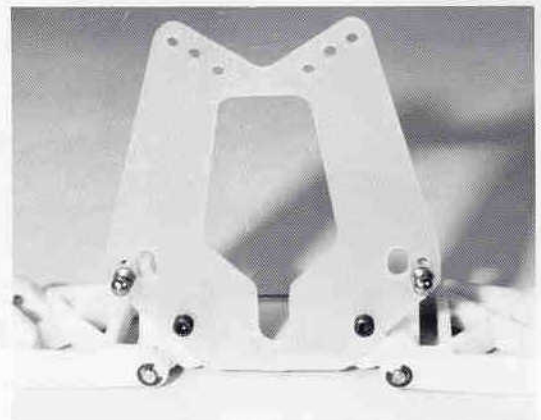
ends are on the back side facing away from the bulkhead (see fig. 15).

(5) Open bag #7-10 (the front shock bag) and remove two each #6927 4-40 x 3/4" SHCScrews, #6295 4-40 plain nuts, and #6936 #4 aluminum flat washers. (6) Install and tighten the #6927 screws in the upper middle hole (if a 3 hole strut; otherwise outside hole if a 2 hole strut) at the top of the front shock strut (see fig. 15). You need to install the screws from the back side so the screw heads are on the same side as the ball ends. (7) Now place a #6936 flat washer over the threads of each screw. (8) Next install and tighten a #6295 nut onto the threads of each screw as shown (see fig. 16). If everything is installed correctly the threads will be on the front side of the shock strut over the front bulkhead.

*Associated's #6960 3/32" Allen wrench will make installing the #6925 screws easier and quicker.*

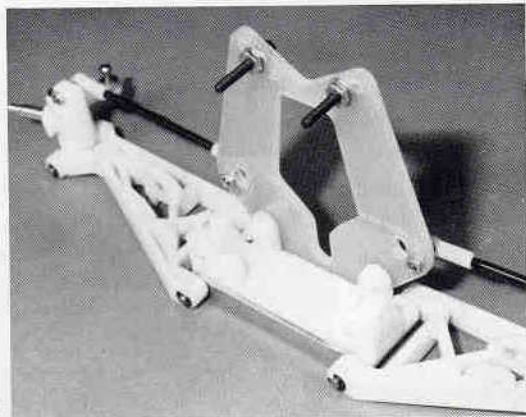


**Fig. 14**



**Fig. 15**





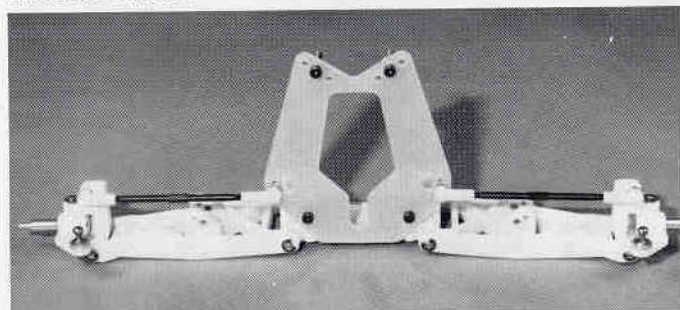
**Fig. 16**

#6295  
4-40 nut  
plain

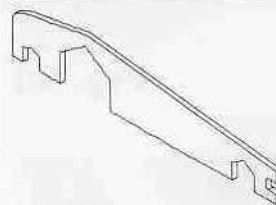
#6927  
4-40 x 3/4

#6936  
#4 flat washer  
aluminum

**Fig. 18** Using a pair of slip joint or needle nose pliers, snap the plastic ball end caps onto the steel ball ends as shown.



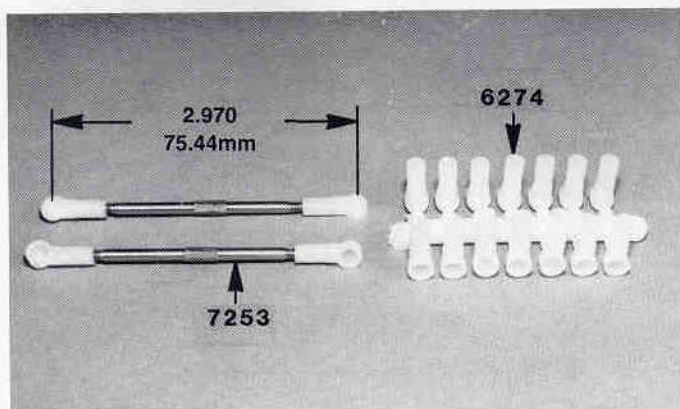
**Fig. 18**



#6955 shock/turnbuckle wrench, not to scale.

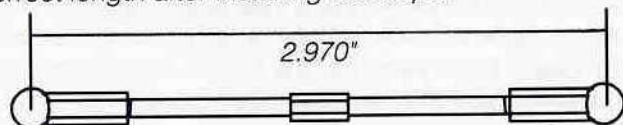
**Fig. 17** In bag #6-14 is a molded tree with fourteen #6274 plastic ball ends; remove four of them. In bag #7-1 are two #7253 2.62" long turnbuckles. Thread the ball ends onto the turnbuckles to the dimensions below. The turnbuckles will screw on in different directions. **THESE DIMENSIONS ARE TO THE CENTER OF THE BALL CUP, NOT TO THE END OF EACH BALL CUP.** These upper suspension links are used to adjust front camber.

In bag #6-14 is a foam strip with pre-cut round #6272 ball end dust covers. Remove four and place them over the ball ends on the strut and over the steering block ball ends. Do this every time you place a turnbuckle on a ball end.

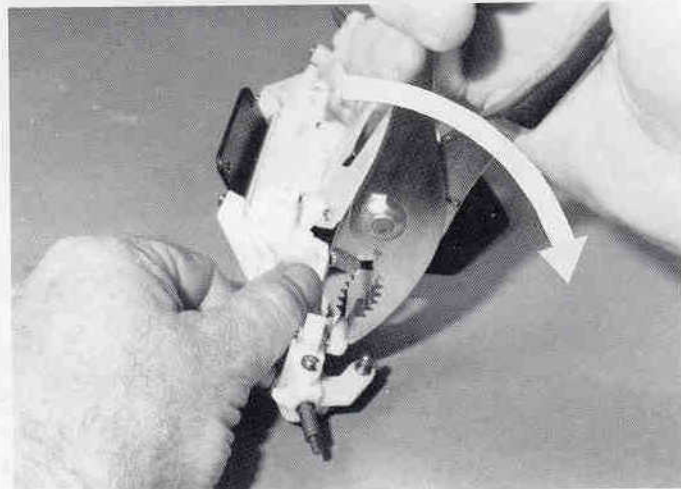


**Fig. 17**

#7253  
2.62"  
correct length after installing ball cups:



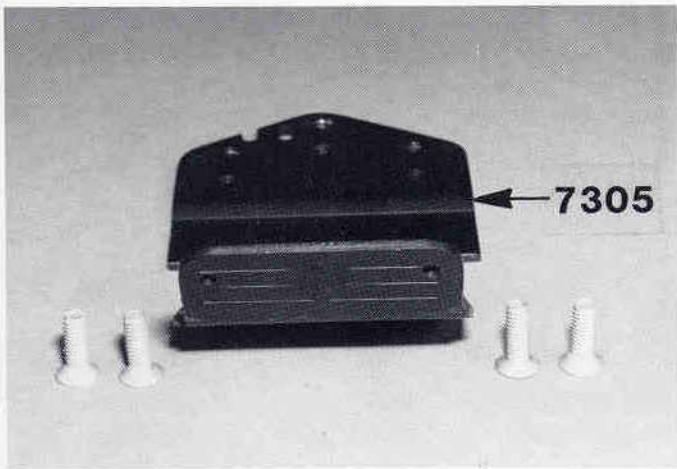
**Fig. 19** The plastic ball end caps can be removed quite easily from the balls by holding the plastic ball end caps close to the ball, as shown, and twisting the plastic ball end cap off of the steel ball end as fig. 19 shows.



**Fig. 19**

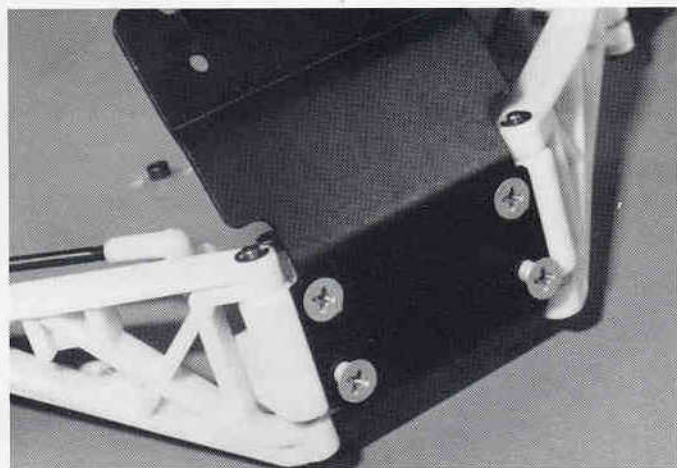
**Figs. 20, 21 & 21A:** Open bag #7-4 and remove the #7305 black aluminum chassis nose plate. Back in bag #7-1 you will find four #6280 8-32 x 1/2" aluminum FHMScrews. Using a #2 Phillips screwdriver we are going to install the front bulkhead assembly to the #7305 nose plate. When you are done, your front end will look like fig. 21A. **DO NOT OVERTIGHTEN.** Tightening them too tight will strip out the nylon.



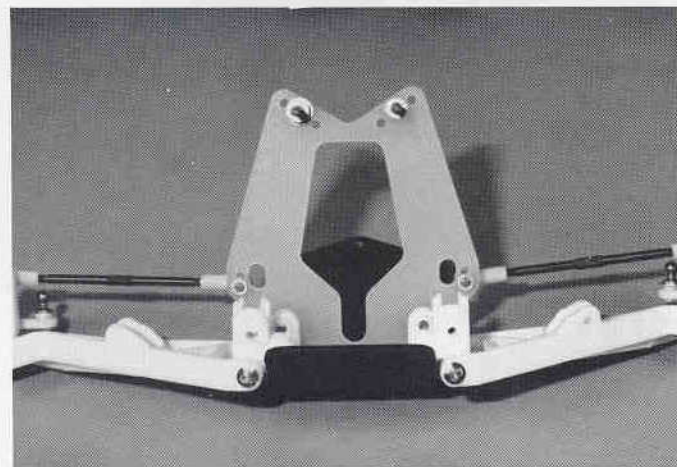


**Fig. 20**

#6280  
8-32 x 1/2  
aluminum

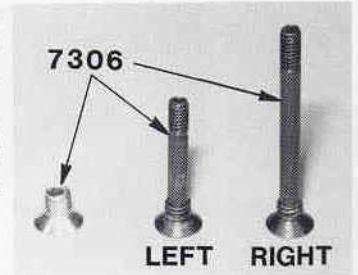


**Fig. 21**



**Fig. 21A**

□ **Fig. 22** From bag 7-4 remove the silver colored #6931 8-32 x 1/4" steel FHMScrew, then open up bag 7-2 and remove the two #7306 special black steel servo saver screws.



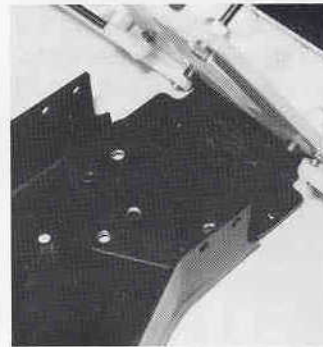
#6931  
8-32 x 1/4  
steel

#7306  
7/8  
special  
left

#7306  
1 3/8  
special  
right

**Fig. 22**

□ **Figs. 23, 23A & 23B** (1) Take the #7525 black anodized aluminum chassis from the kit box. (2) Line up the #7305 black nose plate and front end assembly over the front of the chassis as shown. (3) Line up the #7305 black nose plate over the front of the chassis as shown. (4) Install the small #6931 8-32 x 1/4" FHMScrew from the bottom of the chassis using the center chassis hole and thread it into the back center hole of the nose plate. Do not tighten this screw yet. (5) Install the longer #7306 screw into the right front hole of the chassis from the bottom. It should then thread into the right forward hole of the nose plate. Do not tighten this screw yet. (6) Install the smaller #7306 screw into the left front hole of the chassis. (8) Now tighten the three screws.



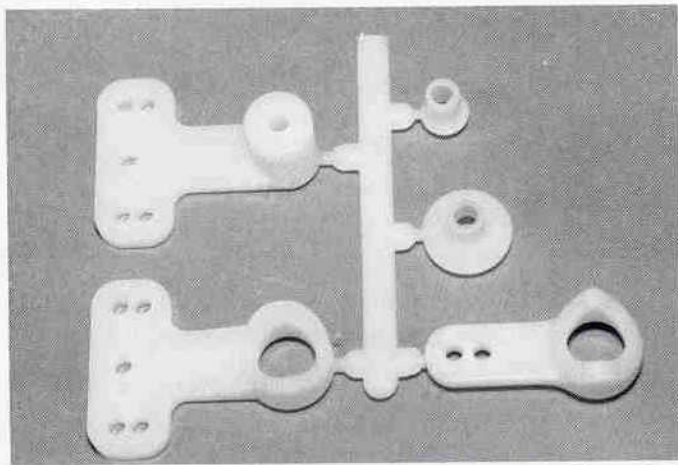
**Fig. 23A**



**Fig. 23B**

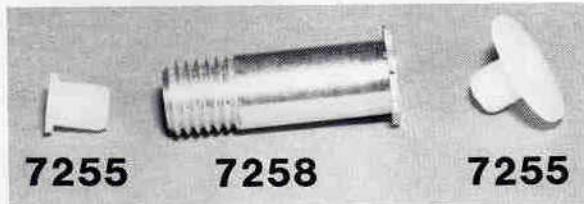
□ **Figs. 24, 25 & 26** In bag #7-2 you will find the #7531 plastic servo saver parts on a molded tree (labeled in fig. 24). In the same bag you will find the #7258 aluminum servo saver tube. Remove the two servo tube bushings from the plastic parts tree, and install them in the aluminum tube as shown. **Note:** A complete replacement set of plastic servo saver parts is #7531. Fig. 26 shows the servo saver tube with the bushings installed.



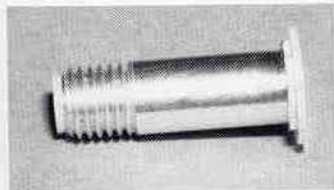


Top left: left hand servo saver arm.  
Bottom left: right hand servo saver arm.

Top right: upper **Fig. 24**  
bushing.  
Middle right: lower bushing.  
Bottom right: servo arm.



**Fig. 25**

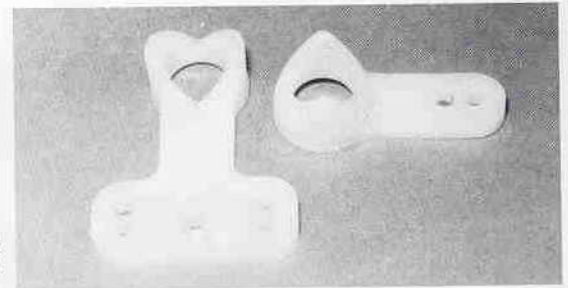


**Fig. 26**

□ **Figs. 27 & 28** Remove the #7531 right hand servo saver arm and the #7531 servo arm from the parts tree in bag #7-2. The right hand servo saver arm is the one with a large hole and V-groove on one end. (1) Slip the right hand servo saver arm over the aluminum tube assembly and slide it all the way down. (2) Now slide the servo arm over the aluminum tube and line up the two V-groove halves. **Racer's Tip:** Team drivers coat the V-groove portion of the servo saver with a very small amount of #6588 black grease to improve its performance. **Note:** If you are using a radio with an extremely large receiver you may have to mount the servo saver and steering servo on the opposite (left) side of the truck, than the standard setup, so that the larger receiver will fit on the right side. The servo saver arms are reversible but the servo arm must always be facing the center of the truck.

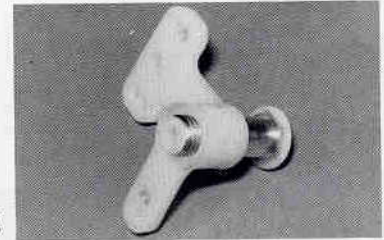
**Fig. 27**

#7351 right hand servo saver arm



#7351 servo arm

**Fig. 28**



□ **Figs. 29 & 30** From bag #7-2 again, remove the #7257 servo saver spring and spring adjusting nut. (1) With the right hand servo saver arm and servo arm pushed all the way down on the aluminum tube, install the #7257 servo saver spring over the tube. There is a groove in the top of the servo arm that the spring will fit into. (2) Now thread on the #7257 spring adjusting nut. (The spring seats into a recess on one side of the spring adjusting nut.) (3) Install the adjusting nut recess side first and tighten until the top of the nut is flush with the top end of the aluminum tube as shown in fig. 30. **Racer's Tip:** The servo saver can be adjusted by tightening or loosening the aluminum adjusting nut which changes the tension on the servo saver spring.



**Fig. 29**



**Fig. 30**

□ **Fig. 31** Go back to bag #6-14 and remove five #6270 short steel ball ends. Remove the #7531 left hand servo arm from bag #7-2. Line up both servo saver arms as shown in fig. 31 and then thread the five #6270 steel ball ends into the locations shown. Install the steel ball in the inside hole of the servo arm. **Note:** You do not need to install nuts on the bottom of these five ball ends.

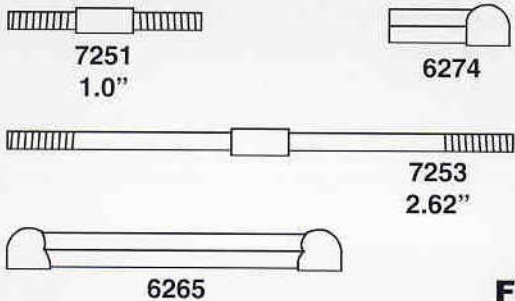




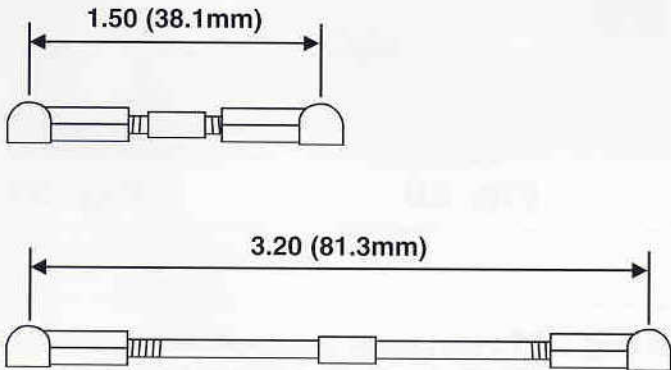
 #6270  
4-40

**Fig. 31**

□ **Figs. 32 & 33** In bag #7-2 you will find one #6265 molded drag link and two #7253 2.62" turnbuckles. From bag #6-14 remove four #6274 plastic ball end cups. Thread the ball cups onto the two turnbuckles to the dimension shown below. **THESE DIMENSIONS ARE TO THE CENTER OF THE BALL CUP, NOT TO THE END OF EACH BALL CUP.** The cups should face the same direction.

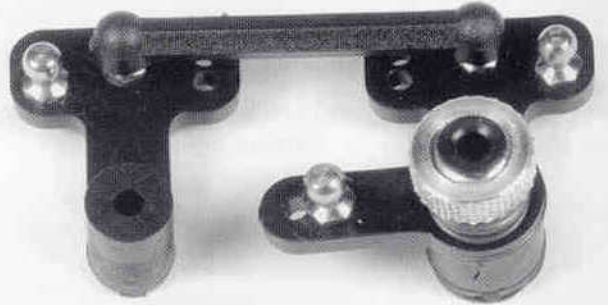


**Fig. 32**



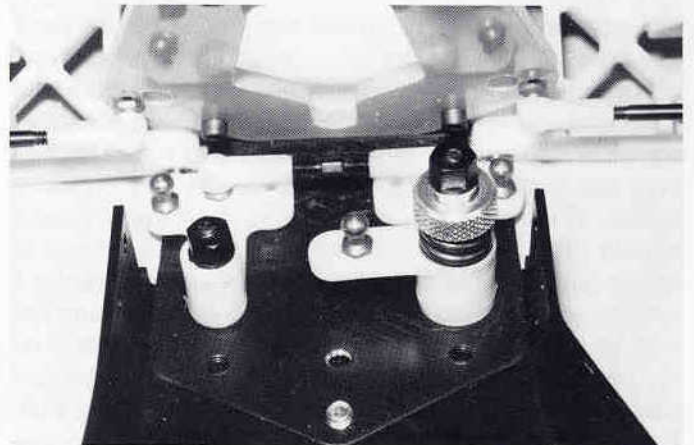
**Fig. 33**

□ **Fig. 34** Take the drag link and snap it onto the two ball ends as shown. Your needle nose pliers will work well here.



**Fig. 34**

□ **Fig. 35** (1) Slip the completed servo saver assembly down onto the two #7306 servo saver mounting screws (that bolt the nose plate assembly to the chassis). (2) From bag #7-2 take out two #6222 4-40/5-40 black self-threading nylon locknuts. Thread one onto each of the servo saver mounting screws. Tighten the nuts down just enough to remove any excess up and down play in each servo saver arm, but **NOT TOO TIGHT**. The servo saver arms should be able to swing to the left and right very freely and be parallel when installed.



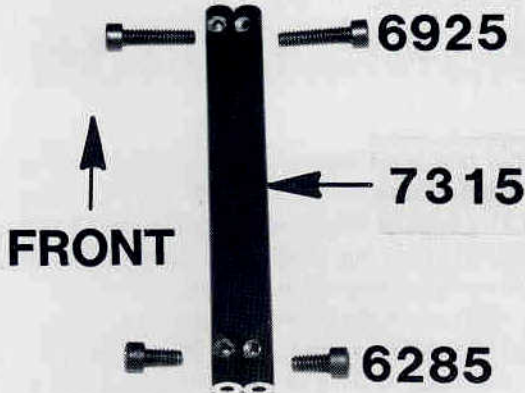
**Fig. 35**



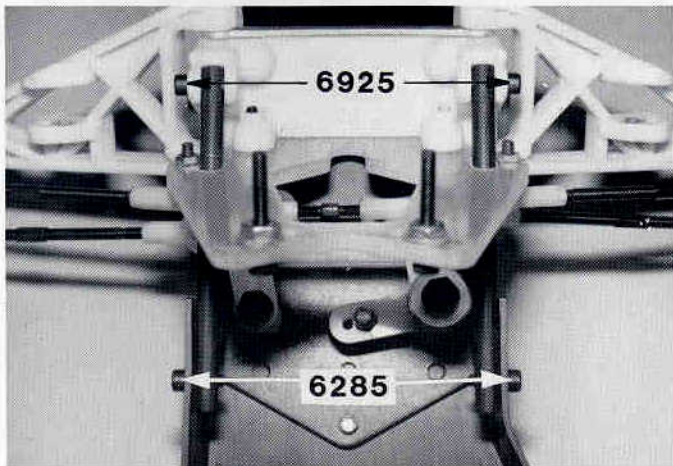
□ **Figs. 36 & 37** From bag 7-4 remove the two #7315 black anodized nose brace tubes. Remove two #6925 4-40 x 1/2" SHCScrews and #6285 4-40 x 1/4" SHCScrews. Install the tubes so the unthreaded screw holes (closest to one end of the tube) will be installed towards the front of the truck.

(1) Slip the unthreaded hole end through the oval shaped hole on the passenger side of the fiberglass shock strut. Align the hole in the tube with the hole in the saddle of the front bulkhead.

(2) Install one of the #6925 4/40 x 1/2" SHCScrews in the front hole but do not tighten it down all the way. (3) Now line up the back hole in the nose brace tube with the hole in the chassis. Install one #6285 4/40 x 1/4" SHCScrew from the outside as shown. Do not completely tighten down the screw. (4) Now repeat the above steps for the nose brace tube on the drivers side. After both tubes and their screws have been installed you can tighten all four screws. Be sure not to overtighten the screws.



**Fig. 36**

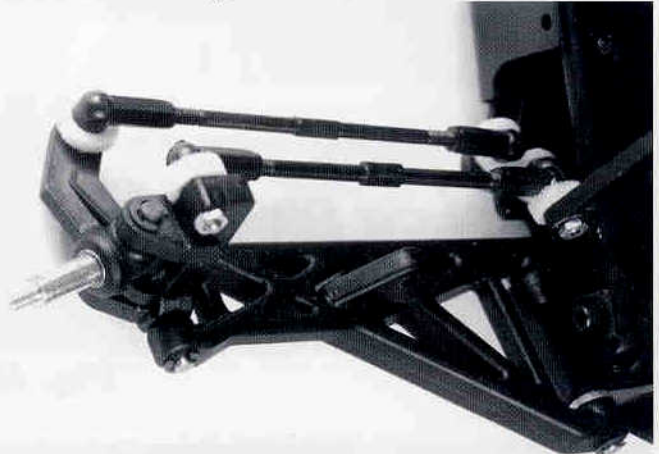


**Fig. 37**

□ #6285  
4-40 x 1/4  
steel

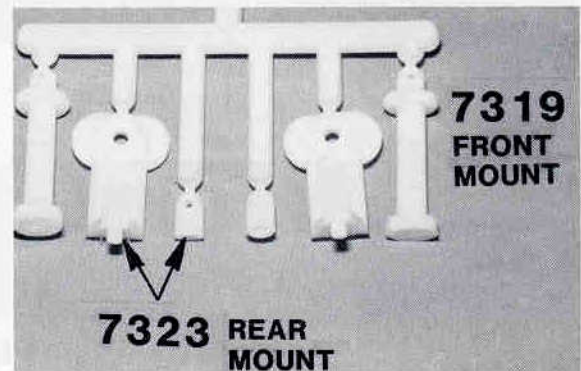
□ #6925  
4-40 x 1/2

□ **Fig. 38** Using your needle nose pliers install both of the longer steering turnbuckles onto the servo saver ball ends and the steering arm ball ends.



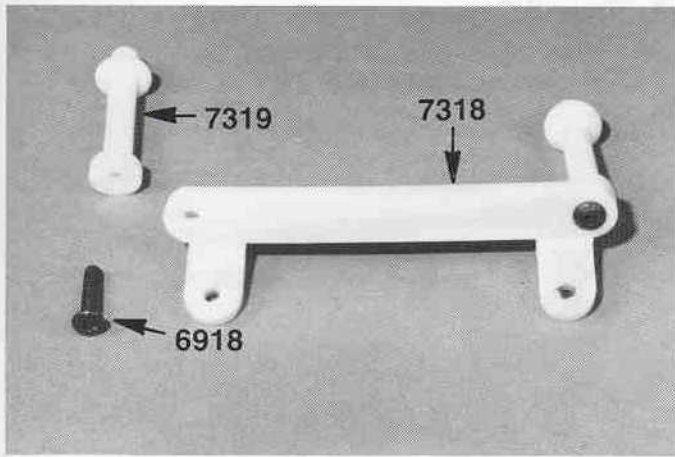
**Fig. 38**

□ **Figs. 39, 40 & 40A** (1) Locate bag #7-5 then remove body mount tree. (Fig. 39 shows the location of the front and rear body mounts on the parts tree.) (2) Remove the two #7319 front body mounts. (3) Go back to bag #7-5 and remove the #7318 front body mount brace and the two #6918 4-40 x 1/2" BHSScrews. (4) Using the two #6918 screws, mount the #7319 front body mounts onto the #7318 front body mount brace as shown in fig. 40. **Note:** Install a #6332 body clip in its mounting hole to hold the mount while you tighten the screw. (5) The small body clip holes should point to the left and right. (6) Tighten the screws, but not too tight. (7) Now we install the front body mount brace assembly to the front bulkhead. Take two #6924 4-40 x 3/8" SHCScrews from bag #7-5. (8) Install the body mount brace over the front bulkhead, facing towards the back. This will put the body mounts over the bulkhead as well and they will be pointing straight up, not at an angle, when properly installed as shown in fig. 40A.

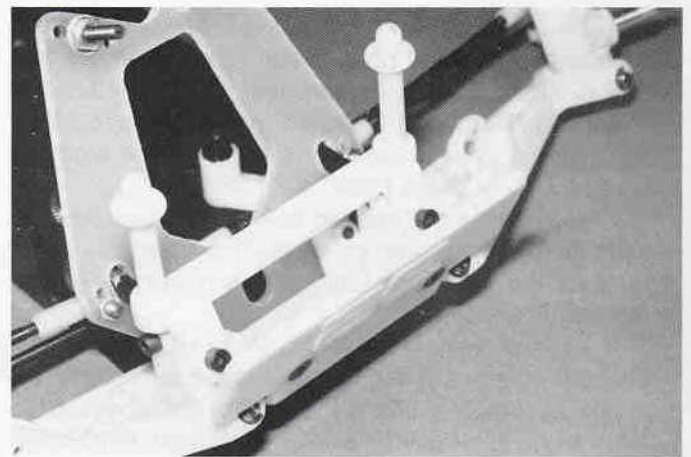


**Fig. 39**

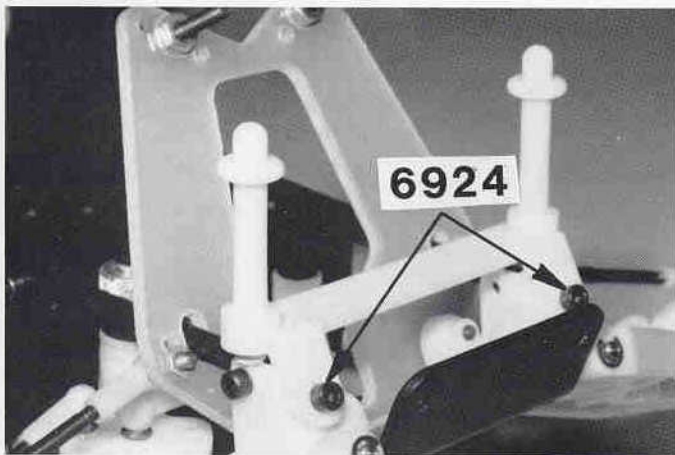




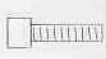
**Fig. 40**



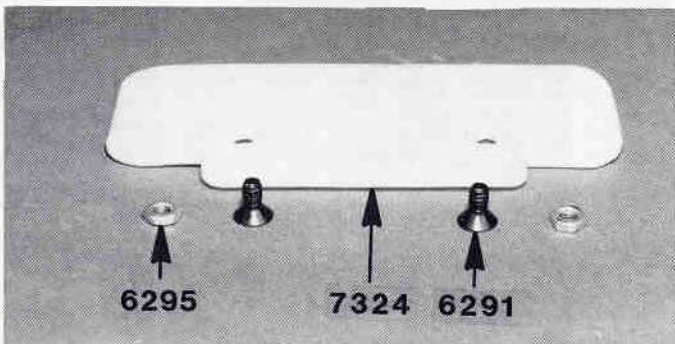
**Fig. 42**



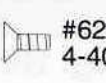
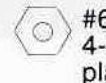
**Fig. 40A**

 #6918 4-40 x 1/2
  #6924 4-40 x 3/8

**Figs. 41 & 42** You will find the #7324 front bumper in bag #7-4. Take two #6291 4-40 x 1/4" FHSScrews and two #6295 4-40 plain nuts from the same bag. The front bumper is recessed on one side so it will fit over the black aluminum nose plate. The front of the bumper has two countersunk holes where you will install the two #6291 flat head screws. Now thread on the two #6295 4-40 plain nuts on the back side of the nose plate and tighten them down.



**Fig. 41**

 #6291 4-40 x 1/4
  #6295 4-40 nut plain

## STEALTH TRANSMISSION

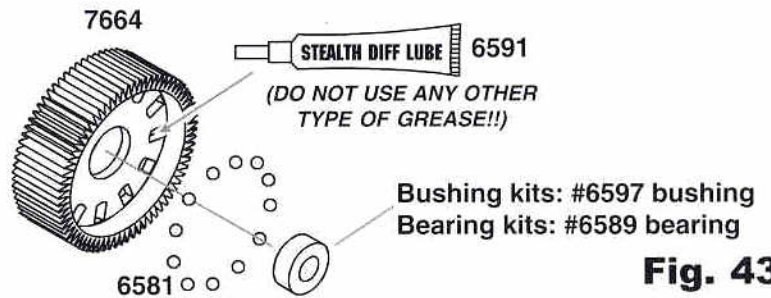
Your gas truck transmission is based on our original Stealth transmission which we feel is the best design in the world. Our original Stealth transmission has enabled Team Associated to win the 1989, 1991, and 1993 2WD off road World Championships. We have also placed 1st, 2nd, & 3rd at the 1990 and 1993 ROAR Nationals and 1st and 2nd at the 1992 ROAR Nationals. In the RC10T we have won the 1991 and 1992 NORRCA Truck Nationals as well as the 1992 and 1993 ROAR Truck Nationals.

Now we have built a whole new Stealth transmission just for the RC10GT gas truck. However, the reduction in the RC10GT Stealth transmission is 2.6:1. With this transmission your gas truck will be more reliable and easier to drive than any other gas powered truck. The consistency of this transmission can enable you to cut your lap times by a considerable amount. But it all depends, of course, on how well you assemble and maintain your transmission. So take your time and do it well.



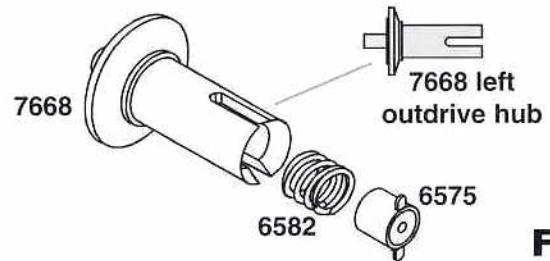
□ **Fig. 43** (1) From bag A remove the #7664 diff gear and the bag containing the twelve #6581 3/32" carbide dif balls. Trim the flash from the center hole of the gear, if necessary. (2) Add a generous amount of #6591 diff lube to the gear ball holes and push in the twelve diff balls. (3) Insert one #6589 bearing or #6597 bushing into the center hole.

○ #6597 5/32" x 5/16" bushing  
○ #6589 5/32" x 5/16" bearing



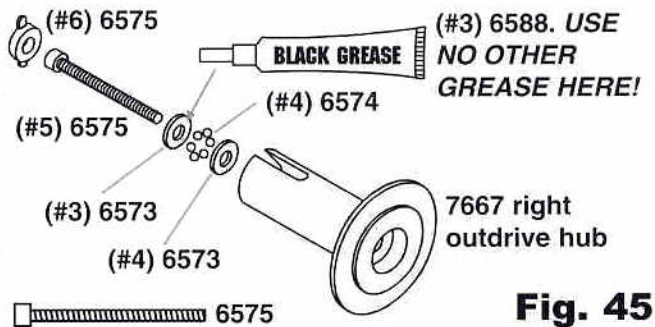
**Fig. 43**

□ **Fig. 44** (1) From bag A remove the #7668 left diff outdrive hub and the #6582 diff thrust spring. Push the spring into the outdrive. (2) Carefully trim the #6575 nylon T-nut from the parts tree so you do not cut off the "ears." Push the T-nut into the outdrive.



**Fig. 44**

□ **Fig. 45** (1) Remove the #6575 2-56 diff thrust bolt and two #6573 diff thrust washers and #6574 precision thrust balls shown from two different bags. (2) Locate your 5/64" Allen wrench from the #6950 tool bag. (3) Slide one washer onto the bolt. Apply a generous amount of #6588 black grease to the washer on the side facing away from the bolt head. (4) Stick six balls into the grease against the bolt and washer. Add the other washer. The grease will hold the balls in place during assembly. (5) Insert your Allen wrench into the diff bolt head and slide the assembly into the #7667 right outdrive hub, being careful not to lose any of the balls. (6) Insert the #6575 bolt cover.



**Fig. 45**

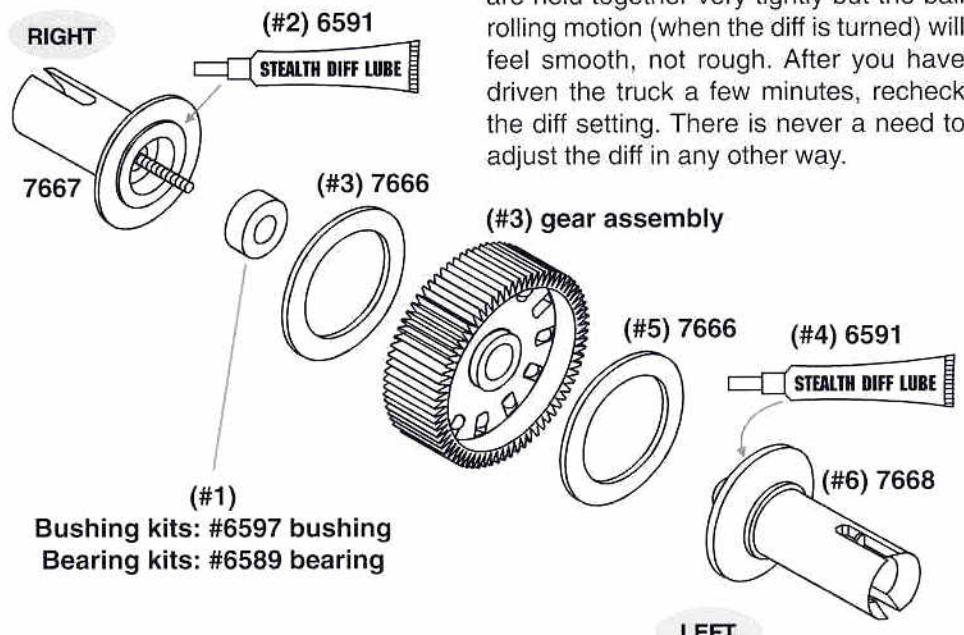
□ **Figs. 46, 65 & 66** (1) Remove one #7666 diff drive ring from bag A. Remove your 5/32" x 5/16" #6589 bearing or #6597 bushing and install it into the right outdrive hub. (2) Add a light coat of #6591 diff lube to right hub where shown. (3) Place a #7666 dif drive ring and then the gear assembly on the hub. (4) Add a light coat of #6951 diff lube to left hub where shown. (5) Place a #7666 dif drive ring on the hub. (6) Push the #7668 left hub over the diff bolt and center the hub.

(7) Now tighten the diff bolt using the Allen wrench, fig. 65. Once you have lightly snugged the two halves together, turn the diff sideways and tighten the diff screw until the spring collapses fully and the screw bottoms out. **DO NOT OVERTIGHTEN!** Correct adjustment is bottoming out the spring and bolt and then backing off the screw 1/4 of a turn. As you are tightening the diff bolt, you will notice the

ears of the T-nut moving closer to the bottom of the slot, fig. 66. The spring and diff bolt should bottom out at about the same time as the T-nut ear reaches the bottom of the slot, but if not, do not worry, just

make sure you bottom out the spring and bolt, then back off 1/4 of a turn.

Your diff should operate very smoothly, not free spinning, when turning the hubs in opposite directions. The parts are held together very tightly but the ball rolling motion (when the diff is turned) will feel smooth, not rough. After you have driven the truck a few minutes, recheck the diff setting. There is never a need to adjust the diff in any other way.

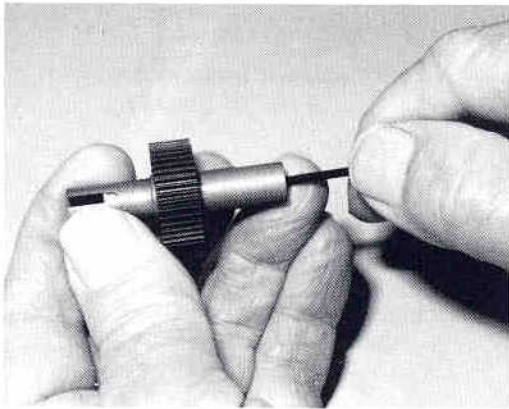


**Fig. 46**

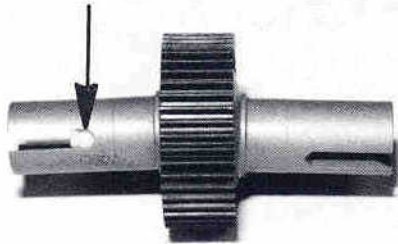
○ #6597 5/32" x 5/16" bushing  
○ #6589 5/32" x 5/16" bearing



**Fig. 65**



**Fig. 66**





□ **Fig. 67** open bag C and remove the #7661 left and right transmission halves. Remove any flashing from them.

**For the ball bearing kits:** From bag B remove four #6906 3/16" plain bearings and two #6903 3/8 x 5/8" sealed bearings. Fig. 67 shows the bearings in the left case half. Install your bearings the same in both case halves. match the bearing size to the cavity size as shown.

**For the bushing kits:** From bag B remove two #6599 3/16" x 3/8" bushing, two #7659 ball bearings, and two #6598 3/8" x 5/8" bushings. Fig. 67 shows the bushings in the right case half. Install your bushings the same in both case halves.



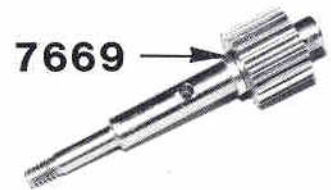
**Fig. 67**

- |                          |   |                     |
|--------------------------|---|---------------------|
| 6906, 3/16" x 3/8"       |  | 6599, 3/16" x 3/8"  |
| <b>ball bearing kits</b> |   | <b>bushing kits</b> |
| 6903, 3/5" x 5/8"        |  | 6598, 3/5" x 5/8"   |

□ **Figs. 68 & 69** Open bag D and remove the #6571 drive shaft/gear assembly and the two #7669 drive shaft spacers. Carefully check the roll pin hole in the drive gear shaft and make sure there are no burrs in the hole or raised edges around the hole. If there are, carefully deburr the hole and remove any raised edges. Be sure to check both sides of the hole. Now take the #6571 drive gear and install one of the #7669 spacers onto the threaded shaft end. Push the spacer all the way down against the gear.

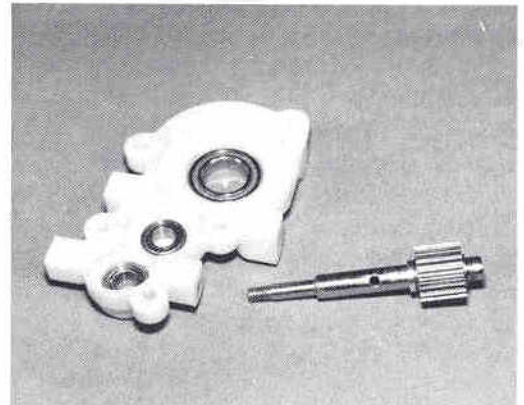


**Fig. 68**



**Fig. 69**

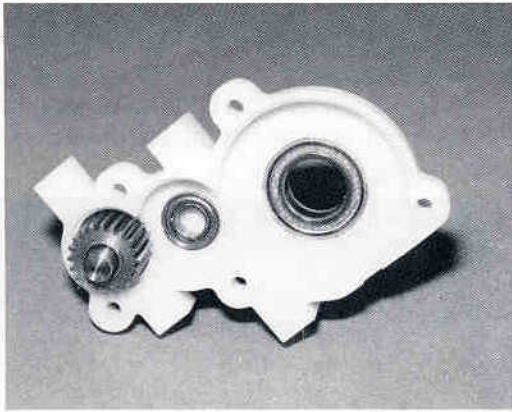
□ **Figs. 70 & 71** Insert the shaft through the upper bearing or bushing of the #7661 right case half so that the shaft is to the outside and the gear is inside against the bearing as shown in fig. 71.



*(ball bearing kits)*

**Fig. 70**

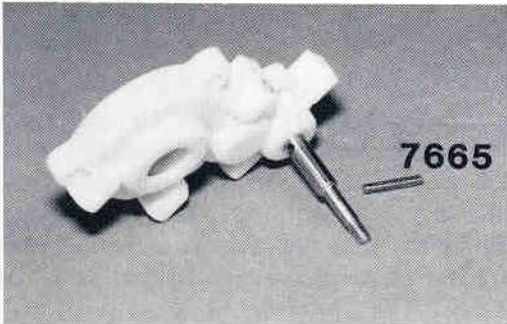




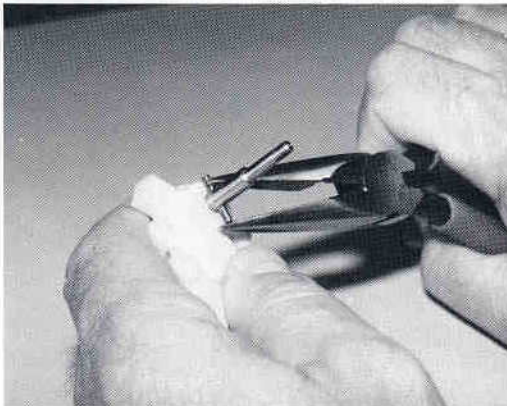
**Fig. 71**

□ **Figs. 72 & 73** Open bag E and remove the #7665 .078" x 7/16" roll pin. Now using a pair of needle nose pliers, squeeze the roll pin into the hole in the #6571 drive shaft (as shown) and center the pin to the best of your ability.

— #7665  
roll pin



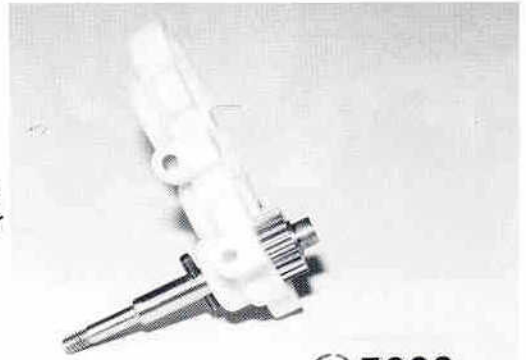
**Fig. 72**



**Fig. 73**

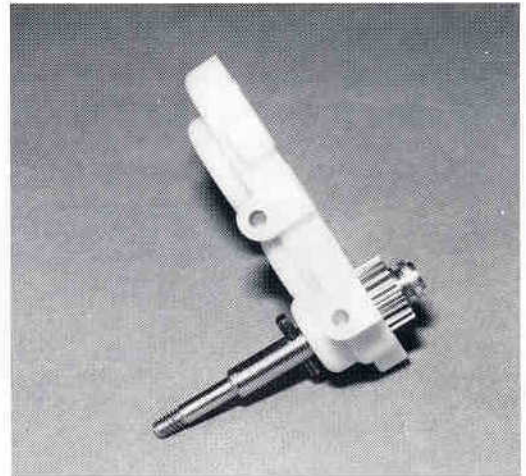
□ **Figs. 74 & 75** Take the second #7669 drive shaft spacer that we took out in fig. 69 and install it onto the drive gear shaft. Slide it all the way down next to the drive gear.

○ #7669  
spacer



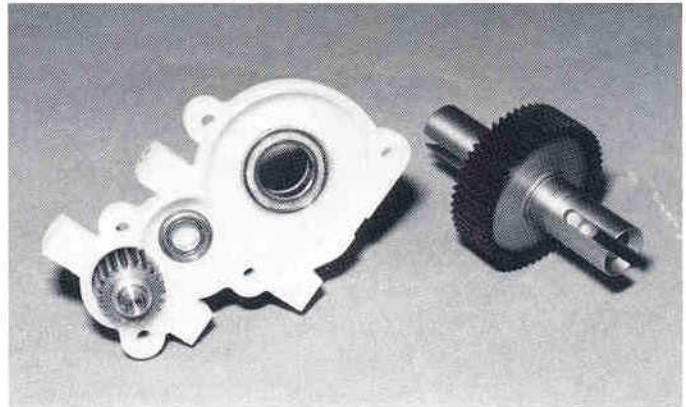
○ 7669

**Fig. 74**



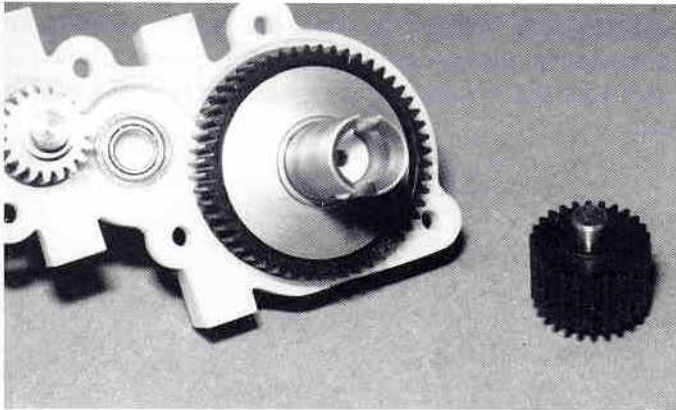
**Fig. 75**

□ **Figs. 76 & 77** Install the assembled diff into the right case half lower bearing or bushing as shown in fig. 77. **Note:** Make sure that you install the diff bolt head side through the right case half. If you install the bolt head so that it is on the driver's side of the transmission you may have a problem with the diff bolt backing off.



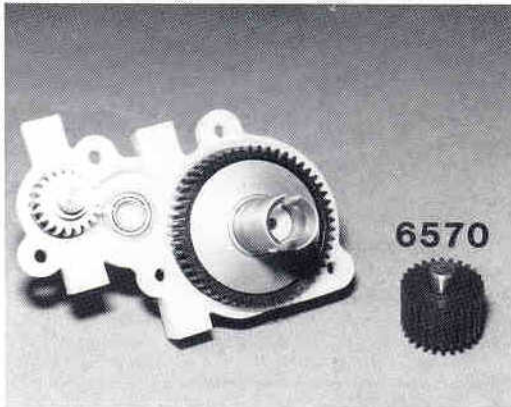
**Fig. 76**



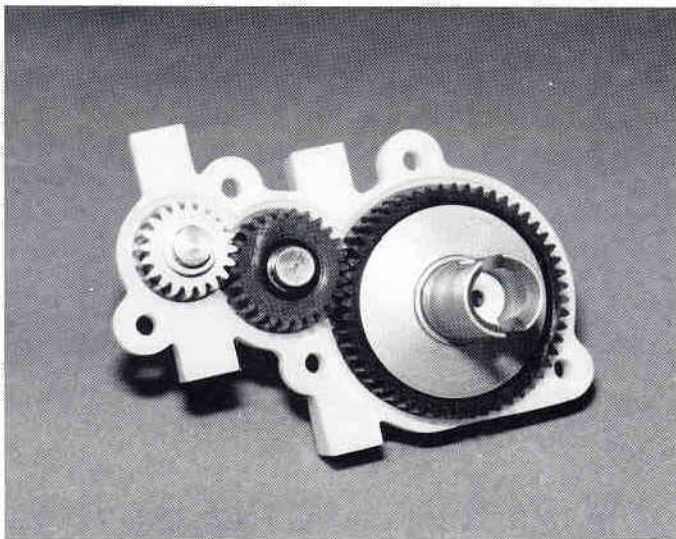


**Fig. 77**

□ **Figs. 78 & 79** Locate the #6570 idler gear and shaft from bag D and install it into the center bearing or bushing location in the right transmission case half. There is no right and left so the gear can go in either way. Fig. 79 shows the right hand case half with all three gears installed.

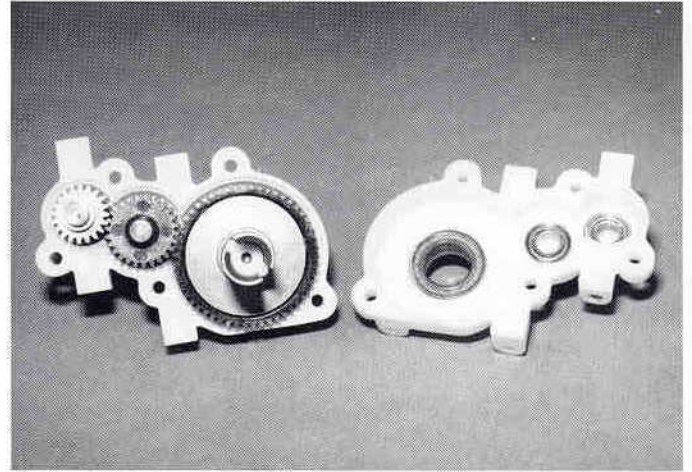


**Fig. 78**



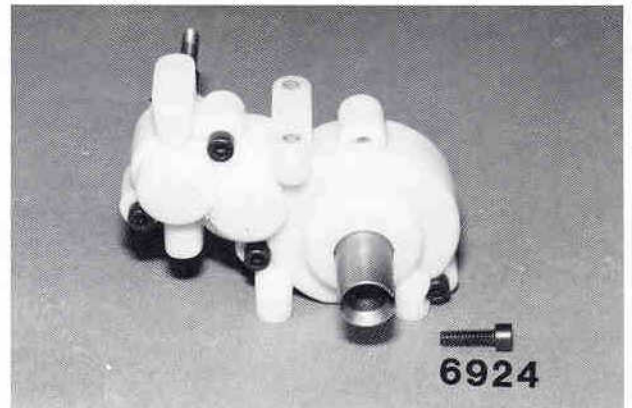
**Fig. 79**

□ **Fig. 80** The photo shows the right case half with gears installed and the left hand case half with bearings or bushings installed. Now take the left hand case and install it onto the gears with the right hand case half. Make sure the drive gear spacer and the bearings or bushings stay in place during assembly.



↑ *(ball bearing kits)* ↑ **Fig. 80**  
right hand case left hand case

□ **Fig. 81** Open bag F and remove five #6924 4-40 x 3/8" SHCScrews. With the left hand case half mounted over the gears making sure that each gear fits correctly into the appropriate bearing or bushing, install the five #6924 screws into the left hand case half and thread them into the right hand case half. Go ahead and tighten down all five screws but don't overtighten them. Now check to see if all the gears turn freely by spinning the diff assembly.



**Fig. 81**

□ #6924  
4-40 x 3/8



□ **Figs. 82, 83 & 84** (1) Now we are going to start assembling the Associated Torque Control clutch and disc brake assembly. From bag E remove the #9251 inner torque control hub (with the slot on the back side as shown in fig. 82). (2) Now open up bag 7-13, and remove the #7554 plastic disc brake adapter, fig. 82. (3) Install the brake adapter onto the inner torque clutch hub with the notches facing up and lining up. (4) From bag 7-13 remove the #7553 brake disc, fig. 83. (5) Install the disc as shown in fig. 84.

(NOTE: If the brake disc is not inside bag #7-13, try the Master Bag.)



**Fig. 82**

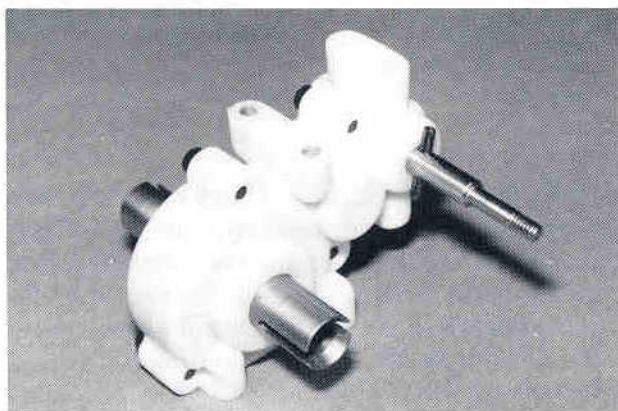


**Fig. 83**

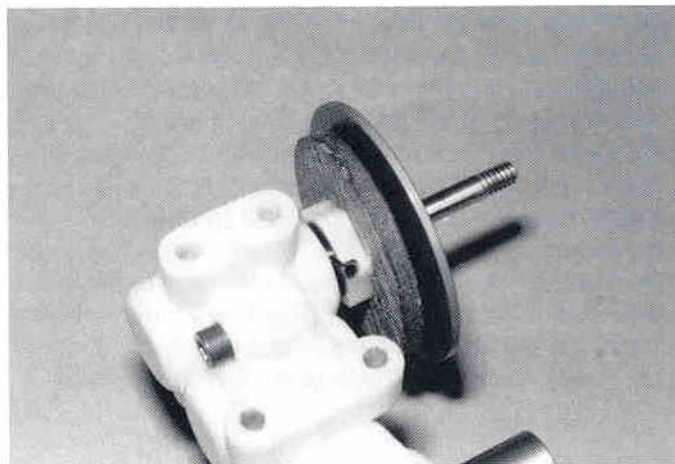


**Fig. 84**

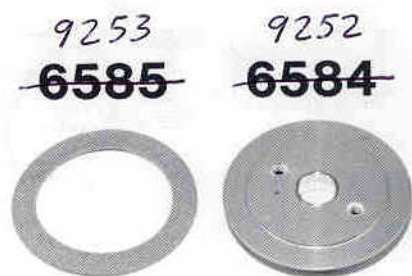
□ **Figs. 85 & 86** Now we need to install the inner torque clutch hub and brake disk assembly onto the #6571 drive gear shaft. The brake disk adapter side of the clutch hub will go onto the shaft first. The clutch hub slot and the notches in the plastic brake disc hub go onto the #7665 drive shaft roll pin. Fig. 86 shows the brake disc and clutch installed.



**Fig. 85**



**Fig. 86**



**Fig. 87**

□ **Figs. 87 & 88**

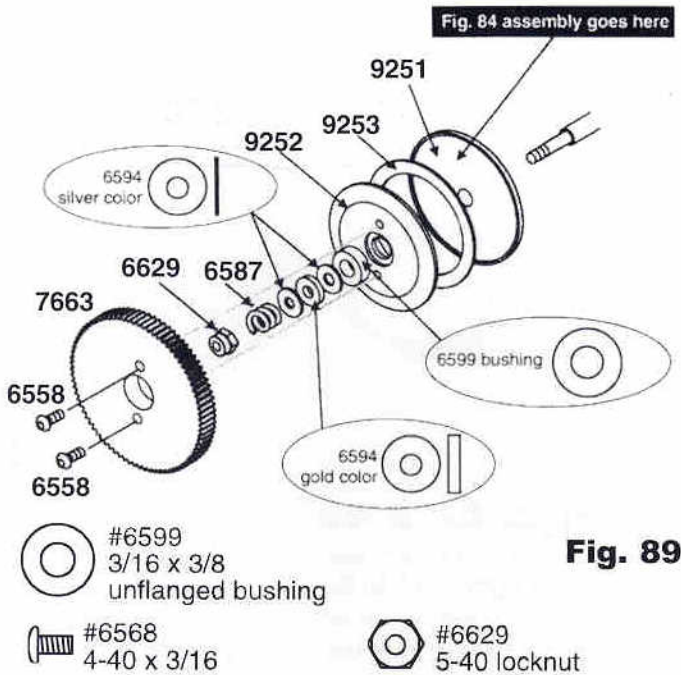
Install the #9253 clutch disc (above left) from bag F to the inside of the #9252 outer Torque Control Hub from bag F.



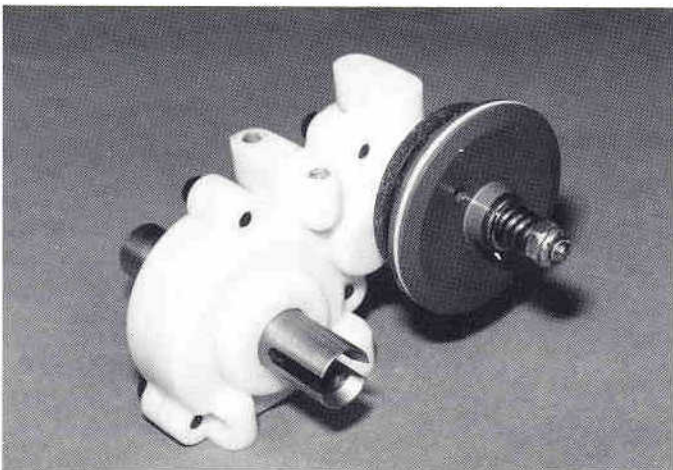
**Fig. 88**



- **Fig. 89** (1) Add the #9251 inner hub (the assembly of fig. 84) to the shaft, lining up the notch with the roll pin. (2) Install the #9253 clutch disc into the inner hub, then add the #9252 outer hub and #6599 bushing. (3) Install parts in the following order: #6594 (thin silver), #6594 (thick gold), #6594 (thin silver), #6587 black spring, #6629 locknut. (4) Orient the #7663 spur gear side facing out as shown and mount to #9252 with two #6568 screws. (5) Tighten the #6629 locknut so the end of the shaft is flush with the end of the nut. This is a good initial adjustment. For further info on the torque clutch, see the tuning section on page 16 of the Engine Installation Manual.

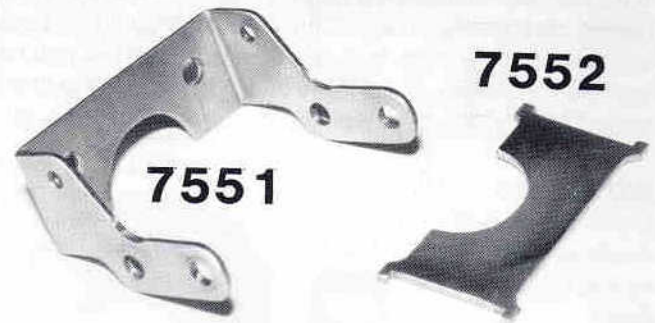


- **Fig. 90** Here is the completed torque clutch and brake disc assembly.



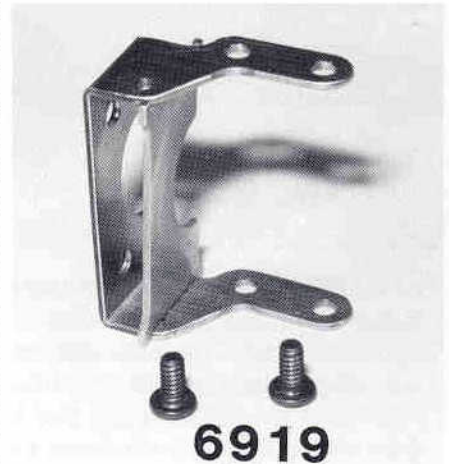
**Fig. 90**

- **Fig. 91** From bag 7-13 remove the #7551 steel brake bracket and #7552 steel brake shoe.



**Fig. 91**

- **Fig. 92** Remove the two #6919 4-40 x 5/16" BHSScrews from bag 7-13. If you look closely at the steel brake shoe you will see that each corner of the shoe has a little tip designed to hold the shoe onto the steel brake bracket without hardware. The brake shoe has sharp edges around one side. This side should face the disk. Slide the brake shoe onto the brake bracket so that the side with the rounded notch in the center is on the same side as the matching notch in the brake bracket.

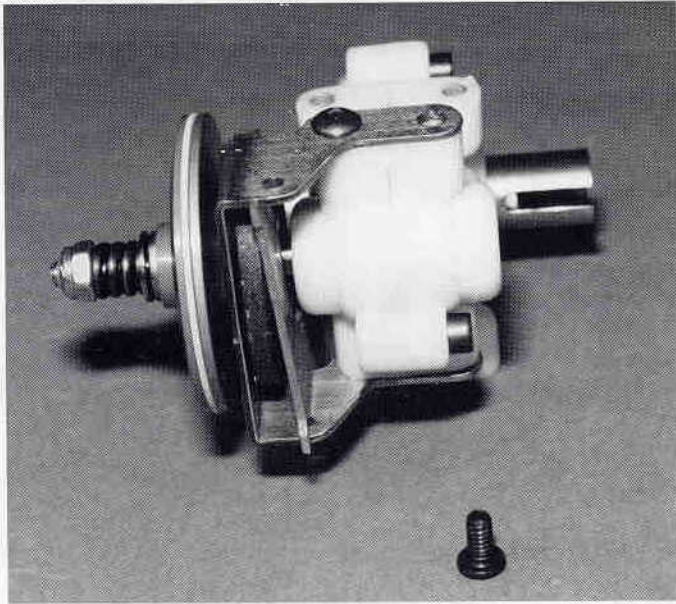


**Fig. 92**

- #6919  
4-40 x 5/16

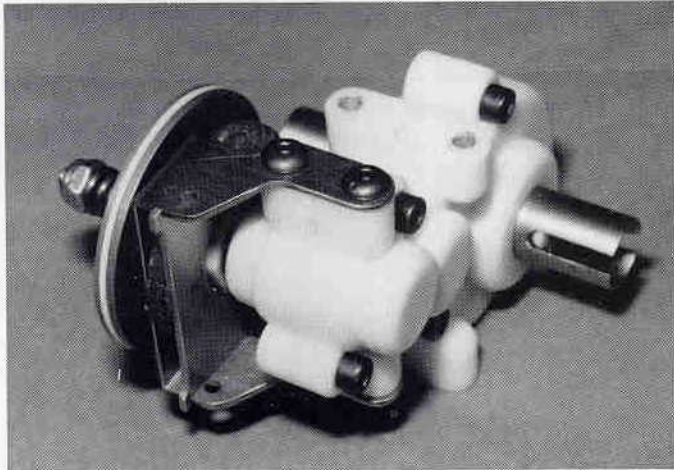
- **Figs. 93 & 94** Mount the brake bracket and shoe onto the transmission. The bracket will be on the outside of the brake disc and the steel brake shoe will be on the inside of the brake disc. The rounded notch in the bracket and shoe are there to clear the brake disc hub. Bolt the bracket to the transmission as shown in the top mounting holes of the brake bracket using the two #6919 BHSScrews. The bottom of the brake bracket will be secured when we bolt the tranny to the chassis.





**Fig. 93**

#6919  
4-40 x 5/16



**Fig. 94**

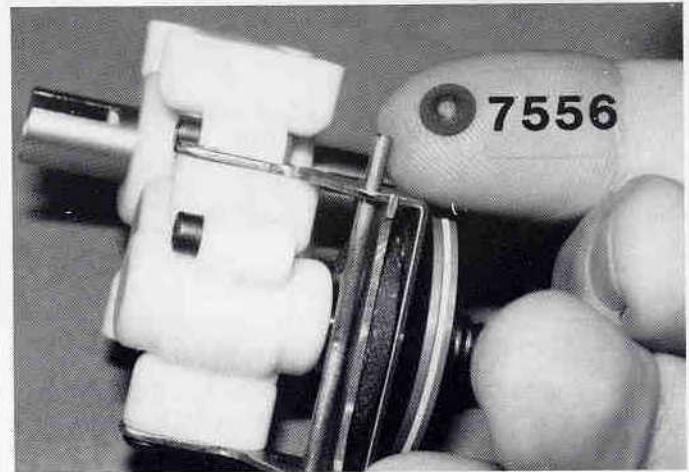
□ **Figs. 95, 96 & 97** From bag 7-13 remove the #7555 disk brake cam and the #7556 brake cam clip. **WARNING!** There is another brake cam clip in bag 7-15. **DO NOT** get the two mixed up. Check the end of the disk brake cam for burrs and remove if found. This will prevent breakage of the brake cam clip during installation. Push the disk brake cam through the hole on the top side of the bracket and then through the hole in the lower end of the bracket. Round the bottom edge of the brake cam.

#7556  
brake cam clip

With the brake cam clip's raised center hole away from the brake cam shaft, install it onto the shaft end (fig. 96) until it almost touches the brake bracket, allowing the brake cam some up and down movement. The best way to install the clip is by using a 3/16" nut driver and pushing down on the clip around the outer edge. **WARNING!** The brake cam clips are designed to be installed and not easily removed. If you make a mistake during installation it may be necessary to destroy the brake cam clip in order to remove it from the brake cam. Take your time and do it right. Fig. 97 shows the cam removed with a brake cam clip installed for clarity.



**Fig. 95**



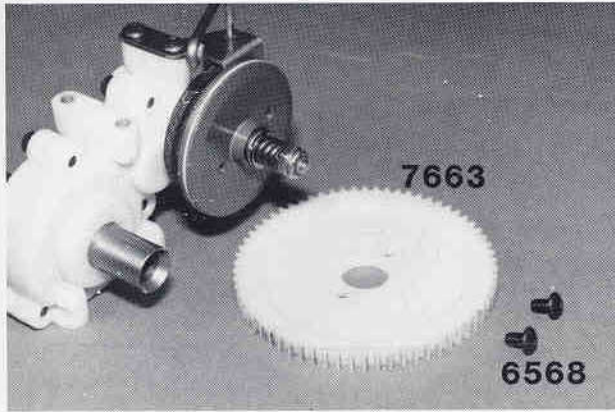
**Fig. 96**



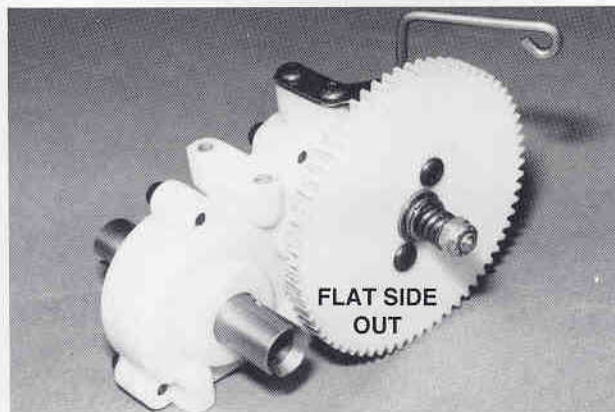
**Fig. 97**



□ **Figs. 98 & 99** Open bag 7-15 and remove the #7663 66 tooth 32 pitch spur gear. Go back to bag F and locate the two #6568 4-40 x 3/16" BHCScrews. If you look at the spur gear you will see one side has a recessed center section and the other side is flat all the way across. Mount the spur gear on the hub with the recessed side contacting the hub, flat side out. Your installed spur gear should look like fig. 99 when properly installed and secured.

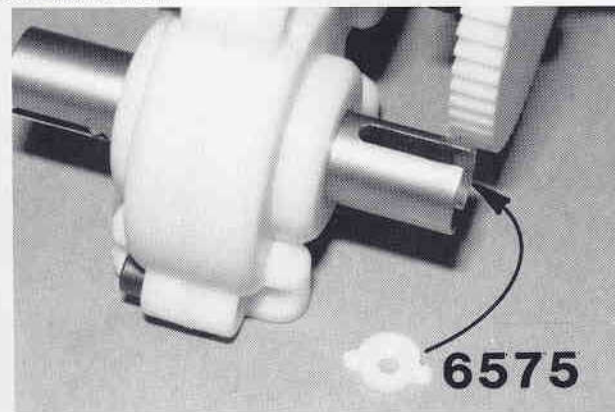


**Fig. 98**

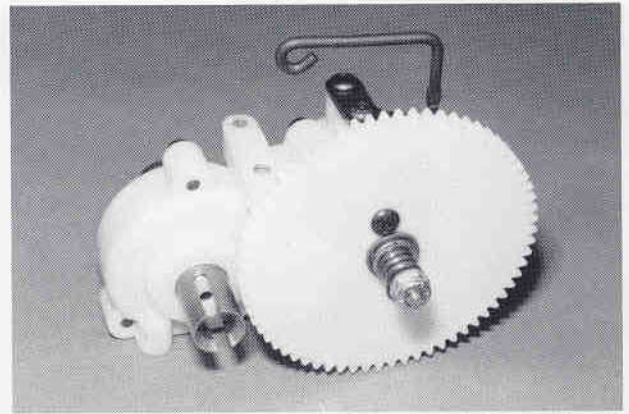


**Fig. 99**

□ **Figs. 100 & 101** Locate the #6575 diff thrust bolt cover we set aside in fig. 49. Install it on the right hand side with the flat side out, pushing it in until it bottoms out in the outdrive hub.



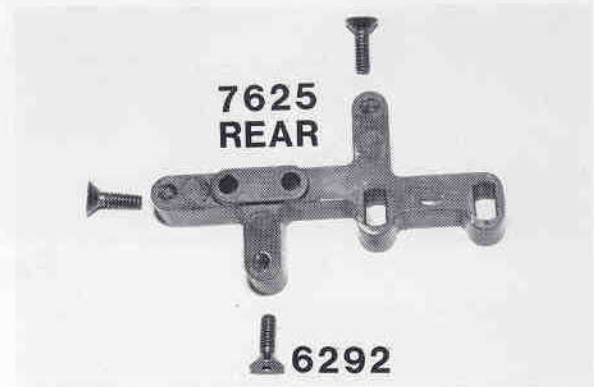
**Fig. 100**



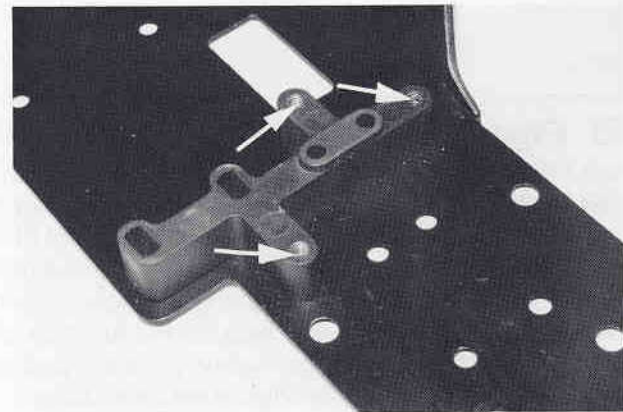
**Fig. 101**

## REAR END ASSEMBLY

□ **Figs. 102, 103, 104 & 104A** Open the engine mount bag #7-16 and take out the two #7625 black engine mounts. Also take out three #6292 4-40 x 3/8" FHSScrews. Fig.102 shows the rear engine mount and the three #6292 FHSScrews used to mount it to the chassis. Fig. 103 shows the rear mount installed on the chassis. Figs. 104 & 104A show the three #6292 screw mounting locations.

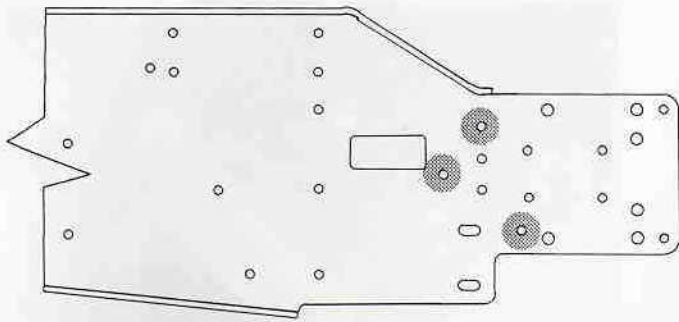


**Fig. 102**



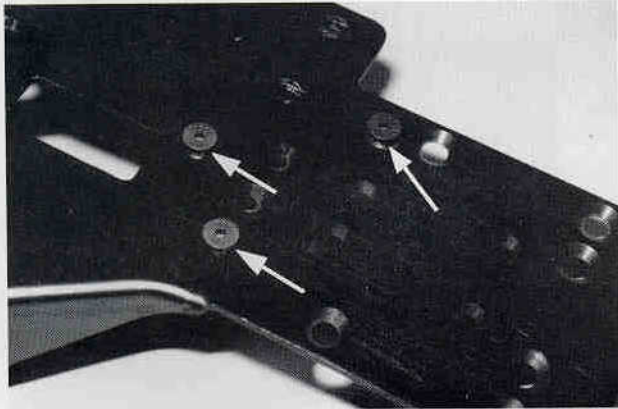
**Fig. 103**






**Fig. 104**

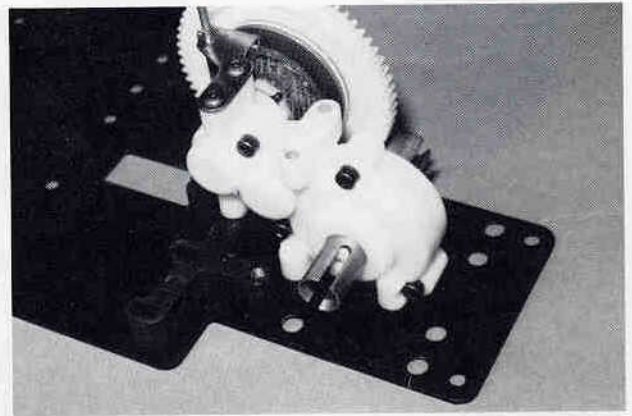
Mounting hole locations  
(TOP VIEW SHOWN)



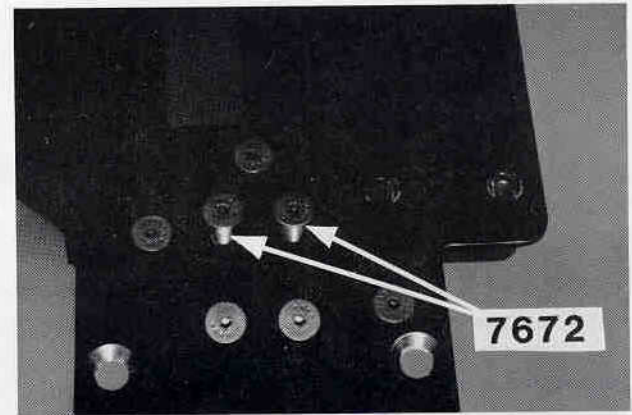
**Fig. 104A**

(BOTTOM VIEW SHOWN)



 #6292  
4-40 x 3/8



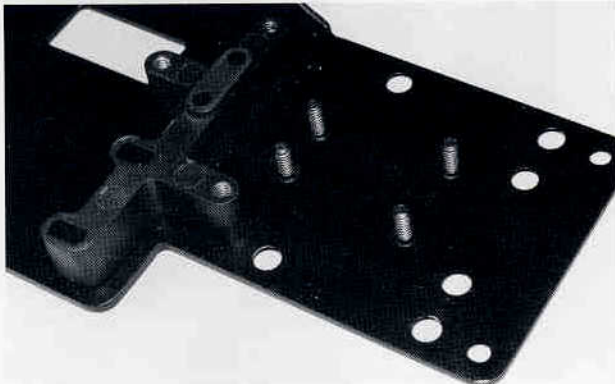
**Fig. 106**



**Fig. 107**

 #7672  
4-40 x 7/8       #7673  
4-40 x 5/16

□ **Figs. 105, 106 & 107** Now go back to bag #F of the transmission and remove the four #7673 4-40 x 5/16" FHSScrews. Fig. 105 shows the four screws installed through the chassis. Now mount the transmission to the chassis as shown in fig. 106. Do not completely tighten the four screws yet. Now take the two #7672 4-40 x 7/8" FHSScrews from bag #7-16. We are going to install these screws through the chassis first as shown in fig. 107. You can now go ahead and tighten all six transmission mounting screws.




**Fig. 105**

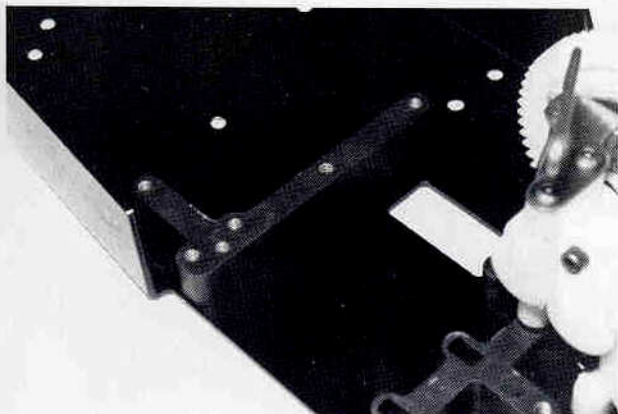
□ **Figs. 108, 109 & 109A** Remove the #7625 front black engine mount that we set aside in fig. 102, and four #6292 4-40 x 3/8" FHSScrews from bag #7-16. Fig. 109 shows the #7625 front engine mount installed.



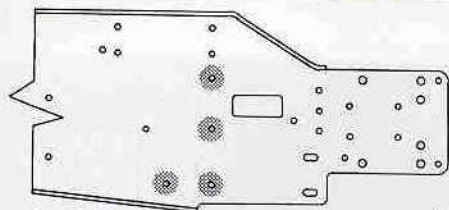
**Fig. 108**

 #6292  
4-40 x 3/8



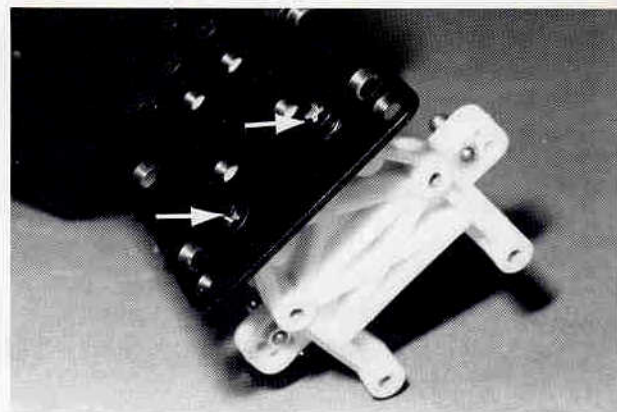


**Fig. 109**

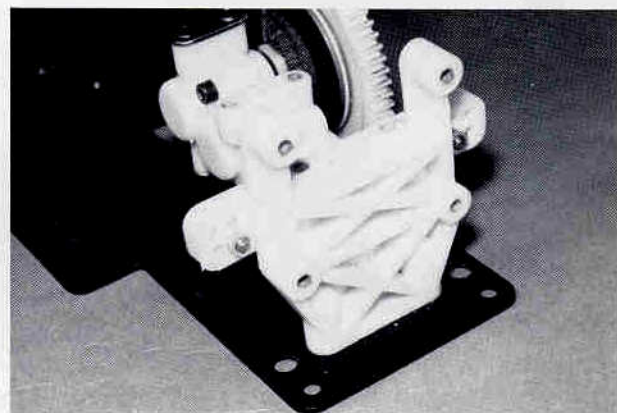


**Fig. 109A**

Mounting hole locations  
(TOP VIEW SHOWN)

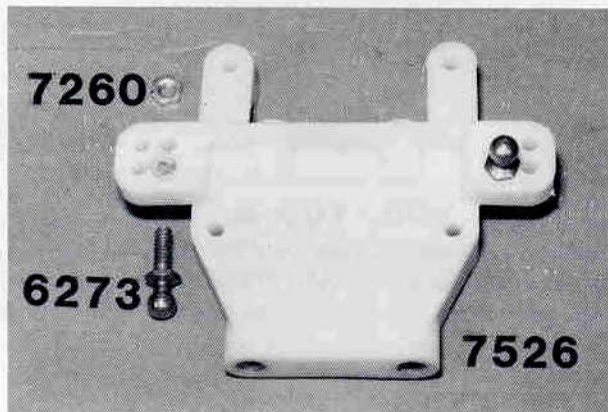


**Fig. 111**



**Fig. 112**

❑ **Fig. 110** Remove the #7526 rear bulkhead from bag 7-4. You will also need to remove two #6273 long steel ball ends and two #7260 small pattern 4-40 plain nuts from bag #6-14. Thread the steel ball ends on the front side of the bulkhead using the bottom inside hole of the four holes available. The front side of the bulkhead is the side WITHOUT the "X" shaped reinforcing ribs (fig. 110). Now turn the bulkhead over and thread on the two small plain nuts.



**Fig. 110**

#7260  
4-40  
thin plain nut

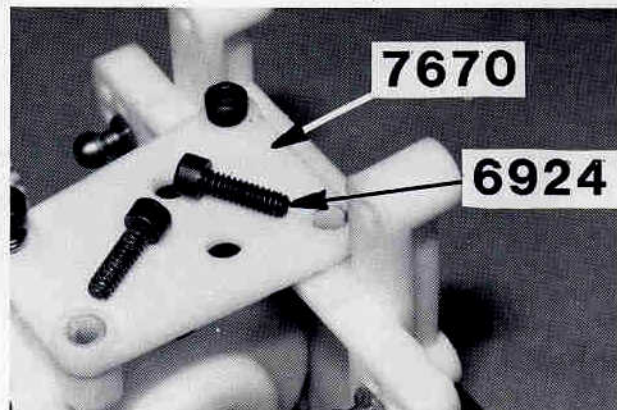
#7658  
8-32 x 3/8

#6273  
4-40

❑ **Figs. 111 & 112** Remove two #7658 8-32 x 3/8" black FHMScrews from bag #7-4. We will use these screws to mount the rear bulkhead to the chassis. Fig. 111 shows where the two screws go on the chassis. Make sure the "X" shaped ribs face the back as shown.

#7658  
8-32 x 3/8

❑ **Figs. 113 & 114** Go to bag #7-4 and remove the #7670 plastic transmission brace and four #6924 4-40 x 3/8" SHCScrews. Mount the transmission brace on top of the rear bulkhead and transmission. It will sit with the small end forward and the raised side on top. Thread your four #6924 screws into the brace as shown in fig. 113. Your completed assembly will look like fig. 114.



**Fig. 113**

#6924  
4-40 x 3/8