

FINAL ADJUSTMENTS

ADJUSTING CAMBER

To set the camber we recommend using our supplied #1719 camber/rear toe-in gauge. When adjusting camber you need to have the car ready to run with no body.

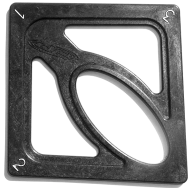

#1719 camber/rear toe-in gauge

Make these adjustments before racing

1. Set your car on a flat surface.
2. When using the camber / rear toe gauge, make sure that the number you want to set it at is at the bottom of the tire. The gauge has 1°,

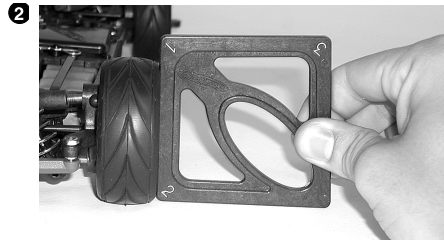

2°, and 3° notations marked on it. Find the 2° and push it against the tire at the bottom.

Use your 5/64" Allen wrench to adjust the upper pivot ball to get 2°. We recommend 2° for most conditions.

CHECKING REAR TOE-IN

We recommended for you to start with 2° of rear toe-in, which is the default setup in the manual. To check or change rear toe-in use the supplied #1719 camber / rear toe-in gauge.

1. Stand your car up vertically on the rear arm mount.
2. When using the camber/rear toe gauge, make sure that the number you want to set it at

is down at the bottom of the tire. The gauge has 1°, 2°, and 3° notations marked on it. Find the 2° and push it against the tire at the bottom.

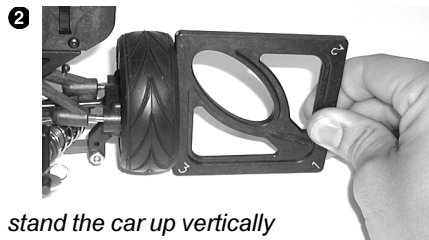

stand the car up vertically

3. Use your supplied #6956 molded turnbuckle wrench to adjust the rear turnbuckle to get the degrees you want.

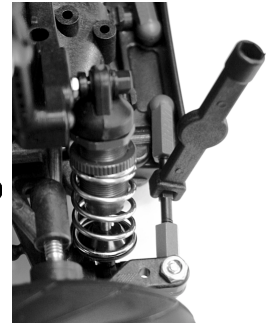

ADJUSTING RIDE HEIGHT

The collars on the bodies can easily adjust the ride height. Use the supplied #1719 track width/ride height tool. The ride height tool will set your car at 5.5mm high.

1. When adjusting the ride height, have the car



#1719 track width/ride height tool

ready to run with no body.

2. Set the car on a flat surface.
3. Slide the height gauge underneath the rear of the chassis, as shown. Raise or lower the shock collar until the gauge just touches the chassis. To get a better measurement on the



chassis, you might need to slide the gauge in the corner of the car. Check both corners of the rear.

4. Slide the gauge underneath the front of the car. Check both corners of the front.

CHECK RADIO / LINKAGE SETUP

CAUTION: Always turn your transmitter on first and off last. Remember this rule. If you start your car before turning on your transmitter then you may lose control of the car and damage the engine quickly.

Test the following transmitter functions without the engine started. These following steps will help you understand the operation of your transmitter.

1. Turn on the transmitter.
2. Turn the car receiver battery pack switch on. Both the steering servo and throttle servo should move to their respective neutral settings.
3. Turn the steering wheel on the transmitter left and right. The front wheels should turn left and right, then return to a perfectly straight-ahead position when the wheel is released. If they're a little off, set the steering with your steering trim. See your radio instruction

4. Pull the throttle trigger, which should open the carburetor on your engine.
5. Push the trigger forward, which should activate the brakes. Hold the throttle open and roll the car over the ground. The car should roll freely. While it is rolling, push on the brakes. The car should come to a stop. If these steps do not produce these results refer to the linkage assembly setup in this manual.

ADD AIR FILTER

NEVER run your touring car without an air filter. The filter is essential for keeping the dirt out of the engine. Refer to your engine manual for the recommended air filter for your engine. If you use a foam filter, use Associated's #7710 foam filter treatment.

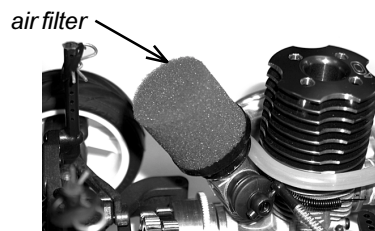

BODY

This kit accepts most 200mm touring car bodies. See body manufacturer's instructions on trimming and painting the body.

CAR FUEL

The proper fuel is very important for long engine life. Improper fuel can cause hard starting, poor performance, and excessive wear on the engine. The fuels we recommend for R/C car use are: O'Donnell Racing Fuel, Duratrax Red Alert fuel, Blue Thunder Race

Formula, FSR fuel, Trinity, Byron's Originals, Traxxas Top fuel, and Wild Cat fuel. There are many other racing fuels; however, they must meet two requirements:

1. The fuel must contain at least 18% of both castor and synthetic oils.
2. You should try to keep the nitro (nitromethane) between 10% to 20%. The

best fuels also contain rust and corrosion inhibitors, anti wear agents, anti foaming agents and lubrication additives.

CAUTION: DO NOT use any type of airplane fuels. Airplane fuels may not have the necessary oil types and ratios needed for R/C cars.

MAINTENANCE

You will find your Nitro TC3 will give you many hours of trouble-free operation when you familiarize yourself with these maintenance procedures.

You should periodically check all the moving parts:

Follow these steps to keep your car in shape for racing

Front and rear a-arms
Steering blocks
Steering linkage
Servo saver
Shocks
Clutch
Brake parts
Bushings and bearings
and other moving areas.

Check the radio system, the condition of the batteries, the fuel tank, and the hoses for leaks. Also check the firmness of the mounting of the receiver and servos, and check for any frayed wires or loose connections. Because of the vibration of gas engines, check the chassis and other critical screws for tightness after every run.

TUNING & SETUP TIPS

Your car is one of the most tunable touring cars on the market. This section will try to explain the parts and adjustments you can use to tune your car for different track conditions.

CASTER

Caster describes the angle of the kingpin from vertical when looked at from the side of the car. Positive caster means the kingpin leans rearward at the top.

The Nitro TC3 standard kit setup is 9° of caster. The car can be adjusted in 3° increments (6°, 9°, and 12°).

These tips prepare your car for maximum performance

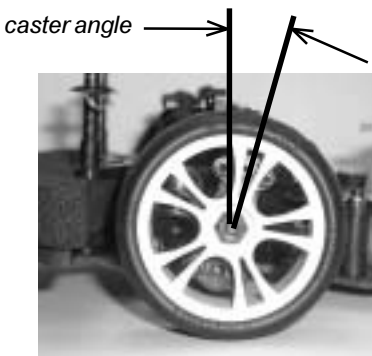

Increasing caster in the nitro TC3 will give your car more turn-in steering, but less steering exiting the corners. It will also be more stable in bumpy conditions. Decreasing caster will give the car less turn-in steering, but will give your car more steering exiting corners. It will be less stable in bumpy conditions.

Change the caster by moving the caster clips shown on page 15, step 6. Both clips to the front results in 6° caster. Both clips to the rear results in 12° caster.

FRONT TOE-IN AND TOE-OUT

You can adjust front toe by turning the steering turnbuckles. Toe-in will make your car easier to drive by improving stability during acceleration. Toe-out will increase steering when entering corners, but will be slightly more difficult to drive. We suggest using 0° to 1° toe-out on the nitro TC3.

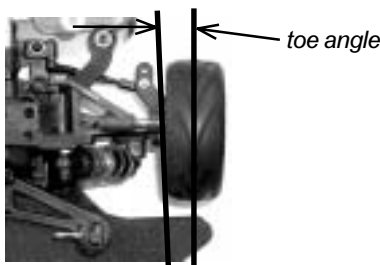

Use this tool on the turnbuckle to adjust toe

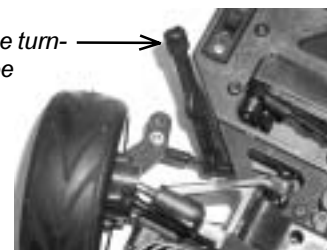

ACKERMAN

This is a term describing the effect of the inside front wheel turning tighter than the outside front wheel. The standard setup works best in most conditions and is preferred by most of our team drivers.

By changing the two #3857 special ball ends with two longer neck #6270 ball ends to the swing rack, a more aggressive steering feeling can be achieved. This is because there will be less Ackerman.

#3857 black short ball ends (in kit)



Standard Ackerman setup

#6270 silver long ball ends (optional)



Optional Ackerman setup

2 SPEED GEARING

Use the following combination of pinion and spur gears in the 2 speed to maintain the correct gear mesh.

20/24 with 52/48	21/27 with 54/48
21/25 with 52/48	20/24 with 54/50
22/26 with 52/48	21/25 with 54/50
23/27 with 52/48	22/26 with 54/50 (in kit)
20/26 with 54/48	23/27 with 54/50

CAMBER

Camber describes the angle the wheels ride relative to the ground when looked at from the front or back. Negative camber means that the tire leans inward at the top. Positive camber means just the opposite, and should not be used. We suggest using 2° to 3° of negative camber on high traction tracks and using 1° to 2° on low traction tracks. Setting the camber was explained to you in Final Adjustments.

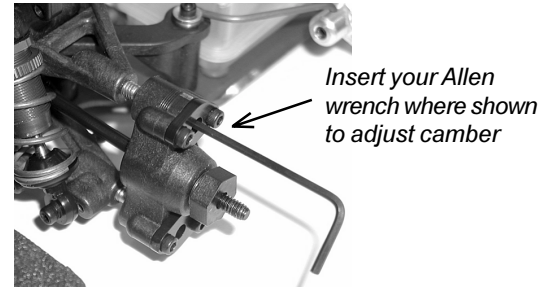
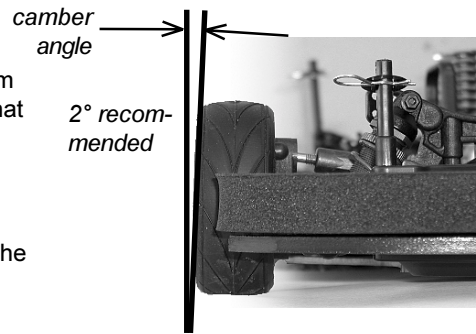

REAR TOE-IN

Toe-in is fully adjustable and can be adjusted by changing the rear turnbuckle length. The setup we recommend is 2° of toe-in on each side. The setting should work best in most conditions. Decreasing the rear toe you will decrease rear traction and add steering. We do not recommend running more than 3° of rear toe-in.

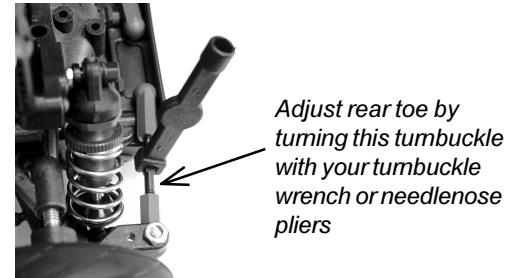
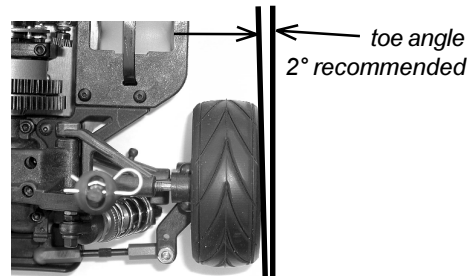

CAMBER LINK LOCATION

The Nitro TC3 has been thoroughly tested to find the best all-around positions. We suggest using the standard setting for almost all conditions.

The optional position will give your car more overall traction in slippery conditions.

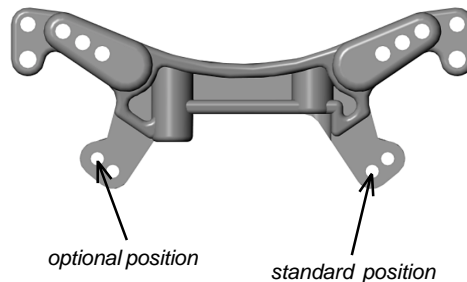

DIFF ADJUSTMENT

By adjusting the front and rear diffs, you can control the amount of steering.

See page 7 for a helpful chart explaining diff settings and their results.

DROOP

Droop can be adjusted on the Nitro TC3 to help speed up or slow down how fast the car changes direction when cornering. The NTC3 standard setup is setting 4 in the front and setting 3 in the rear. This will work best in most track conditions. See page 5 for setting droop.

If your track is bumpy, you may want to add droop to your car by going to a lower droop gauge setting.

If your track has very high traction then you what to take droop out of your car by going higher on the droop gauge. Too little droop will cause a loss of traction.

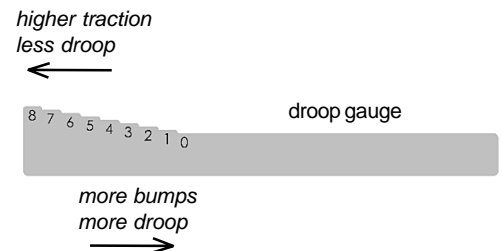

TWO-SPEED ADJUSTMENT

By increasing or decreasing the spring tension you can change the shift point of your two-speed. If you want the car to shift into second gear later, tighten down both screws equally ¼ of a turn to increase the spring tension. If you want the car to shift into second gear sooner, loosen both screws equally ¼ of a turn to decrease the spring tension. Make your adjustments in ¼ turn amounts. Run your car first before you make any adjustments to the two-speed.

To adjust your 2-speed (turn off your engine):
1. Lift the car and hold the spur gear in place with your thumb, the bell opening (3) facing up.

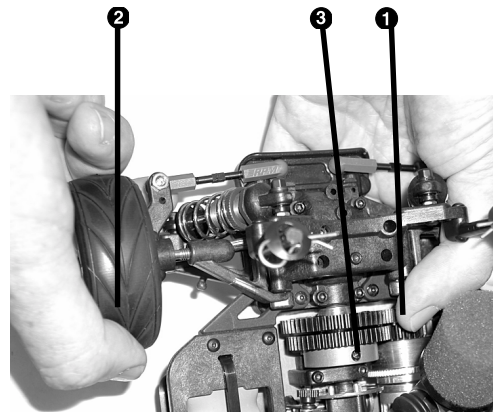

2. Turn the rear wheel slowly.
3. Watch for the adj. screw to appear in the opening of the 2-speed bell. It will be a black screw, at an angle. When looking at the front of the 2-speed, there will be a number 1 and 2 on the shoes where the adjustment

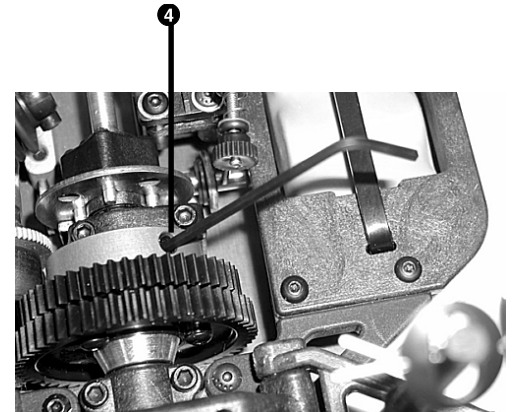

screws are located.
3. Insert your Allen wrench and adjust as needed.
4. Remove Allen wrench and turn the rear wheel again and repeat for the second set screw, adjusting it the same amount.

SHOCK SPRINGS

Shock springs keep your car level during acceleration, deceleration, and cornering.

Stiffer springs will help your suspension respond more quickly, but because of their stiffness will not absorb bumps as well. Use stiffer springs in high traction conditions.

Softer springs are best for slippery or bumpy conditions.

Part #	Color Code	Rating
#3941	Green	12 lbs.
#3942	Sliver	14.5 lbs.
#3943	Blue	17 lbs.
#3944	Gold	19.5 lbs.
#3945	Red	22 lbs.
#3946	Copper	25 lbs.
#3952	Purple	30 lbs.
#3953	Yellow	35 lbs.
#3954	White	40 lbs.

ANTI-ROLL BARS (optional)

Roll bars are used to stabilize a car from excessive chassis roll (which occurs when your car leans through the turns by centrifugal force). Anti-roll bars are generally used on smooth, high traction track conditions. If the track is bumpy and slippery, then roll bars are not needed.

If you're driving on a high traction condition and your car wants to oversteer, then use optional #1715 front blade anti-roll bar kit. This will decrease the front chassis roll and decrease steering throughout the corner.

If your car is understeering, then try the optional #3960 anti-roll bar kit in the rear only. The rear anti-roll bar will decrease rear chassis roll and decrease rear traction.



#1715 Front Blade Anti-roll Bar Kit (optional)

CLUTCH ADJUSTMENT

When the engine revs increase, the clutch shoes, attached to the flywheel on the shaft inside the clutch bell, are flung outward by centrifugal force. The shoes engage to the inside of the clutch bell, which in turn power the clutch bell to accelerate the car. The shorter the clutch shoes or the stiffer the clutch spring (optional), the higher the engine must rev before the clutch shoes will engage. This is recommended for lower power engines. The stock (longer) length clutch shoes and stock clutch springs (softer) will have the quickest engagement. This is recommended for most track conditions and high power engines.

To adjust your clutch, you can change the number of shoes, alter their length or change the clutch spring. Changing shoes

mainly depends on the current track conditions. The stock clutch springs are recommended for most conditions. In general, the higher the traction the longer the shoes, which prevents tire spinning. To decrease the clutch engagement, try cutting the clutch shoes a little shorter using a hobby knife. Cut to equal lengths. Do not trim away more than necessary or your engine can get damaged due to the engine over-revving.

Optional Parts:

- #2324, non pull start 3-shoe flywheel
- #2325, pull start 3-shoe flywheel
- #2307, optional clutch springs

SETUP SHEET

A blank setup sheet for the NTC3 is included. Set up your NTC3 with the standard settings then deviate from them in response to your track conditions and driving style, as noted below.

Tips for beginners:

For best results, make only one setup change at a time, testing it before making another change. Make a copy of the setup sheet included in the back of this manual to help keep track of your changes.

Before you make any changes to the standard settings, make sure you can get around the track without crashing. None of your setup

changes will work if you cannot stay on the track.

Your goal is consistent lap times. Inconsistent lap times may indicate poor control. When you have consistent lap times, then make changes to your car.

If the change results in a faster lap, then mark the change in your setup sheet. If performance is worse, then revert back to the previous setup and try another change.

Fill out your setup sheet thoroughly when you are satisfied with it and file it away. It can be a practical guide for future track layouts and conditions you encounter.

TRACK WIDTH

You can adjust the track width of the NTC3. That is, you can widen the distance between the outside front wheels.

To adjust the track width of your car, see the instructions on page 14.

STANDARD SETTINGS for rubber

tires (See next page for standard settings for foam tires)

1. Front camber: 2°.
2. Front camber link: inner hole on tower.
3. Front caster: 9°.
4. Front toe: 0°.
5. Front ride height: 5.5mm
6. Front Droop: 4 on droop gauge
7. Bump steer spacers: none.
8. Ackerman: #3857 ball ends.
9. Front anti-roll bar: none.
10. Rear camber: 2°.
11. Rear camber link: inner hole on tower.
12. Rear toe-in: 2°.
13. Rear ride height: 5.5mm
14. Rear anti-roll bar: none.
15. Rear Droop: 3 on droop gauge.
16. Driveshafts: MIP CVD's.
17. Shock body: alum. macro shock.
18. Shock oil: front & rear: 40 wt.
19. Shock shaft, front & rear: #8844
20. Shock pistons: Front, #3. Rear, #2.
21. Shock springs: Front, copper. Rear, gold.
22. Shock mounting, front tower, middle hole. Arm, outer hole.
23. Shock mounting, rear tower, middle hole. Arm, outer hole.
24. Fuel brand: varies.
25. Fuel nitro: 20%.
26. Engine brand: varies.
27. Engine 12 or 15: varies.
28. Engine temp: about 220°.
29. Pull or non pull start: varies.
30. Carb type: varies.
31. Clutch shoes: uncut, with STD springs.
32. Radio: varies
33. Servo: varies.
34. 2-speed adj: 3 1/2 turns c-clockwise.
35. 2-speed clutch: 22 & 26
36. Tires, front: Pro-Line (#3955 STD)
37. Tires, rear: Pro-Line (#3955 STD)
38. Tire additive: none.
39. Inserts: incl. with tires.
40. Wheels: Pro-Line.
41. Spur gears: 50 & 54.
42. Track width: use track width gauge.
43. Lead weights: none.
44. Chassis: stock
45. Body: varies.
46. Wing: varies with body.



SETUP SHEET for the Team Associated

Driver _____
 Track / City _____
 Event _____ Date _____

FRONT SUSPENSION

CASTER ___ 6° ___ 9° ___ 12° ANTI-ROLL BAR
 ___ none
 CAMBER ___ ° ___ 3960 kit
 ___ 1717 front blade kit
 TOE-IN ___ ° ___ blade setting
 RIDE HEIGHT ___ mm ACKERMAN
 ___ STD (3857 ball ends)
 DROOP _____ ___ opt. (6270 ball ends)
 BUMP STEER SPACERS _____ " DRIVESHAFTS
 ___ MIP
 ___ other

FRONT SHOCKS

BODY
 ___ threaded
 ___ other
 SPRING (color) _____
 OIL ___ wt
 PISTONS # _____
 SHAFTS
 ___ unobtainium
 ___ STD

TOWER MOUNTING
 ___ inner hole
 ___ middle hole
 ___ outer hole
 CAMBER LINK
 ___ inner hole
 ___ outer hole
 ARM MOUNTING
 ___ inner hole
 ___ outer hole

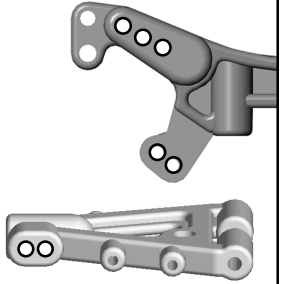

REAR SUSPENSION

CAMBER ___ ° ANTI-ROLL BAR
 ___ none
 TOE-IN ___ ° ___ 3960 kit
 RIDE HEIGHT ___ mm DRIVESHAFTS
 ___ MIP
 DROOP _____ ___ other

REAR SHOCKS

BODY ___ threaded ___ other
 SPRING (color) _____
 OIL ___ wt
 PISTONS # _____
 SHAFTS
 ___ unobtainium
 ___ STD

TOWER MOUNTING
 ___ inner hole
 ___ middle hole
 ___ outer hole
 CAMBER LINK
 ___ inner hole
 ___ outer hole
 ARM MOUNTING
 ___ inner hole
 ___ outer hole

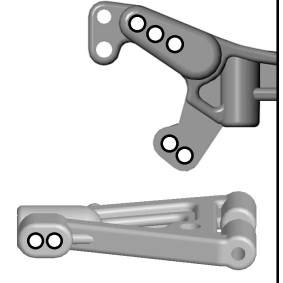

OTHER

FRONT TIRES _____
 FRONT INSERTS _____
 FRONT WHEELS _____
 REAR TIRES _____
 REAR INSERTS _____
 REAR WHEELS _____
 TIRE ADDITIVE _____
 ___ none
 TRACK WIDTH
 ___ STD (gauge) ___ (in./mm)
 WEIGHTS
 ___ none ___ (oz./gm)

FUEL BRAND _____
 NITRO ___ 20% ___ %
 ENGINE BRAND _____
 ___ pull start ___ non pull start
 ___ .12 ___ .15 ENG. TEMP. ___ °
 CARB ___ rotary ___ slide valve
 CARB RESTRICTOR ___ none ___ "
 ONE-WAY ___ none ___ front
 SOLID AXLE ___ front ___ rear
 FRONT DIFF SETTING _____
 REAR DIFF SETTING _____

BODY _____
 RADIO _____
 ST. SERVO _____
 THR. SERVO _____
 1st GEAR PINION / SPUR ___ / ___
 2nd GEAR PINION / SPUR ___ / ___
 CLUTCH ___ 2 shoes ___ 3 shoes
 CLUTCH SHOES ___ not cut ___ cut
 CLUTCH SPRINGS ___ STD ___ other
 GLOW PLUG TYPE _____
 TUNED PIPE _____

TRACK CONDITIONS

SURFACE ___ smooth ___ bumpy
 TRACTION ___ low ___ medium ___ high
 COMPOSITION ___ concrete ___ asphalt ___ carpet
 specify: _____
 NOTES _____

RACE COMMENTS

MAIN ___ FINISH ___ QUALIFYING POS. ___
 NOTES _____

CAR COMMENTS

NOTES _____

PERFORMANCE COMPONENTS FOR THE NITRO RC10TC3



- 1402 FACTORY BLUE 1.375 Turnbuckles
- 1414 FACTORY BLUE 1.125 Turnbuckles
- 1415 FACTORY BLUE Rear Toe Turnbuckles
- 1450 FACTORY TEAM Ride Height Gauge, set ride height easily
- 1594 FACTORY TEAM Body Hole Reamer
- 1596 FACTORY TEAM Locking Adhesive, locking screws to metal
- 1597 FACTORY TEAM Tire Adhesive, glues tires to plastic wheels
- 1598 FACTORY TEAM Shock Cap, Blue anodized aluminum
- 1700 NTC3 FT Light Weight Two-Speed One-Way Hub
- 1701 NTC3 FT Light Weight Two-speed Clutch Housing
- 1702 NTC3 FT Light Weight Two-Speed Clutch Bell
- 1704 NTC3 Solid F/R Axle
- 1706 NTC3 FT Blue Alum. Center Bulkhead
- 1707 NTC3 Front One-Way assembly
- 1708 NTC3 FT Blue Alum. Pull Start Motor Mounts
- 1709 NTC3 FT Brake Cam Bearing Kit
- 1710 NTC3 FT Blue Alum. Non Pull Start Motor Mount:
- 1711 NTC3 FT Teflon Sealed Bearing Set
- 1712 NTC3 FT Blue Alum Main Drive Shaft
- 1713 FACTORY BLUE NTC3 Turnbuckle Kit
- 1714 NTC3 FT Swing Rack Bearing Kit
- 1715 NTC3 FT Front Blade Roll Bar Kit
- 1717 NTC3 FT Blue Alum. Blade Roll Bar Mounts
- 1719 FACTORY TEAM Camber + Track Width Tool
- 1721 Clutch Nut Wrench 3/8
- 1722 FACTORY TEAM Graphite Radio Tray
- 2234 NTC3 Carbon Front Arm Set
- 2241 NTC3 Carbon R/L Steering / Hub carriers
- 2244 NTC3 Carbon Rear Arm Set
- 2248 NTC3 Carbon F/R Shock Tower
- 2255 NTC3 Carbon Chassis Braces
- 2259 NTC3 Carbon Radio Tray
- 2261 NTC3 Carbon Handle
- 2324 NTC3 Non Pull 3 Shoe Flywheel
- 2325 NTC3 Pull Start 3 Shoe Flywheel
- 3888 FACTORY BLUE TC3 / NTC3 Aluminum CVD Bones
- 3939 TC3 / NTC3 Front One-way / Solid axle Differential Ring
Gear with /Mounting Screws
- 3941 TC3 / NTC3 Green Spring, 12.0 lbs.
- 3943 TC3 / NTC3 Blue Spring, 17.0 lbs.
- 3945 TC3 / NTC3 Red Spring, 22.0 lbs.
- 3946 TC3 / NTC3 Copper Spring, 25.0 lbs.
- 3949 TC3 / NTC3 Wheel Hex Adapters, Graphite
- 3952 TC3 / NTC3 Purple Spring, 30.0 lbs.
- 3953 TC3 / NTC3 Yellow Spring, 35.0 lbs.
- 3954 TC3 / NTC3 White Spring, 40.0 lbs.
- 3960 TC3 / NTC3 Rear Anti-roll Bar Kit
- 3962 FACTORY BLUE-Anodized TC3 / NTC3 Threaded Shock Kit (4)
includes Collar and O-rings .35"
- 3964 TC3 / NTC3 UNOBTANIUM Shock Shafts
- 3965 TC3 / NTC3 Axle Bearing Spacers, Blue.
- 3968 FACTORY BLUE Counterfeit Transponder
- 3972 TC3 / NTC3 Blue Aluminum Hex Drives
- 3988 Complete TC3 / NTC3 Tuning Spring Kit (9 pair)
- 6439 FACTORY TEAM Shock Cap, Blue anodized aluminum
- 6937 FACTORY BLUE 4-40 Aluminum Locknuts
- 6943 FACTORY BLUE 8-32 Aluminum Locknuts
- 7710 Pre Filter Treatment



VISIT TEAMASSOCIATED'S WEB SITE FOR:

- Setup sheets
- New products
- Tuning tips —setting up your car to the track
- Customer support
- Body painting ideas in the Racer's Spotlight section
- Computer wallpaper
- Catalog and manual
- Subscribe to our FREE *Team Associated Insider's Newsletter*—delivered right to your e-mail box!
- Racer apparel and car carrier
- Hobby shop & track locations worldwide
- Spring rate chart and other charts
- Nitro engine troubleshooting tips
- Helpful tools
- R/C Forum

NITRO TC3

